



FILED this 15th day of Jan 2015
2:45 P M
CAROL HOLCOMB
COUNTY CLERK, CALDWELL COUNTY, TEXAS
By Sherry Hays Deputy

Notice of Meeting

Commissioners Court of Caldwell County, Texas

Notice is hereby given that a meeting of the Caldwell County Commissioners Court will be held on the 20th day of January, 2015 at 9:00 A.M. in the 2nd Floor Courtroom, Caldwell County Courthouse located at 110 S. Main Street, Lockhart, Texas at which time the following subjects will be discussed, considered, passed or adopted, to wit:

Note: Commissioners Court Meeting packets are prepared several days prior to each meeting. This information is reviewed and studied by the Court members, eliminating lengthy discussions to gain a basic understanding. Timely action and short discussion on agenda items does not reflect lack of thought or analysis on the part of the Court.

Start times for regular agenda items are tentative; some items may be held earlier or later than the scheduled time.

For the convenience and comfort of members of the public and Caldwell County officials and employees, the Commissioners Court may take a recess from 10:30-10:45 a.m. and from noon to 1:30 p.m.

Agenda

Call Meeting to Order.

- 2015.01.20.01** **Invocation.** Lockhart Ministry Alliance.
- 2015.01.20.02** **Pledge of Allegiance to the Flags.** (Texas Pledge: Honor the Texas Flag; I pledge allegiance to thee, Texas, one state under God, one and indivisible).
- 2015.01.20.03** **Announcements.** Items or comments from Court Members or Staff.
- 2015.01.20.04** **Citizens' Comments.** At this time any person may speak to Commissioners Court if they have filled out a Caldwell County Commissioners Court Participation Form. Comments will be limited to four (4) minutes per person. No action will be taken on these items and no discussion will be had between the speaker(s) and members of the Court. The Court does retain the right to correct factual inaccuracies made by the speakers. (If longer than 30 minutes, then the balance of comments will continue as the last agenda item of the day).

2015.01.20.05 **Consent Agenda.** (Any member of the Court may request that an item within the Consent Agenda to be moved to the Regular Agenda for further discussion and action).

A. To approve a Proclamation to honor Chief Jerry Doyle for serving the City of Lockhart for 43 years.

2015.01.20.06 **Reports.**

Unit Road Systems Report – Dwight Jeffrey
Maintenance Report – Curtis Weber

To acknowledge receipt of Federal Inmate Report, General Fund Report, Tax Collection Report from County Auditor, Larry Roberson.

2015.01.20.07 **Special Presentation.** None

(ALL OTHER AGENDA ITEMS)

2015.01.20.08 **Executive Session** pursuant to Sections 551.071 and 551.087 of the Texas Government Code: Consultation with counsel and deliberation regarding economic development negotiations associated with Project Cast. Possible action may follow in open court. **Speaker: Commissioner Munoz**

2015.01.20.09 **Discussion/Action** to authorize the County Judge to execute a License Agreement with Camp Gladiator for use of the Justice Center Grounds. Cost:\$0 **Speaker: Commissioner Munoz/ Assistant District Attorney, Jordan Powell. Backup:1.**

2015.01.20.10 **Discussion/Action** to consider purchase of floor cleaning equipment for the Caldwell County Justice Center. Price comparison is as follows: GBC total cost \$10,924.83. Jco Janitorial Supply total cost \$9,309.00. Texas Smart Buy total cost \$8,864.17. **Speaker: Commissioner Roland/Curtis Weber. Backup:3.**

2015.01.20.11 **Discussion/Action** to approve Budget Amendment #2014-05 Emergency Management / Homeland Security. Caldwell County received a grant from Flint Hills Resources to benefit first responders and emergency management operations. This amendment adjusts the budget to reflect the revenue received and the expenditure of the funds. There is no net increase of expenditures. Cost:\$0 **Speaker: Judge Schawe/Larry Roberson. Backup: 1.**

2015.01.20.12 **Discussion/Action** to approve Budget Amendment #2014-06 Capital Projects-Justice Center. At the December 8th, 2014 meeting, the Commissioner's Court approved the reduction of the contract with Braun & Butler by \$226,302.00. This amendment transfers the savings to the contingency fund to be used for equipment and the maintenance contract with Braun & Butler. Cost:\$0 **Speaker: Judge Schawe/Larry Roberson. Backup: 1.**

- 2015.01.20.13** **Discussion/Action** to approve Budget Amendment #2014-07 Non Departmental/Maintenance Department. The attached purchases were approved by the Commissioner's Court at the November and December 2014 meetings. The contracted services represents one-third of the total contract amount of \$144,337.00 for a three year maintenance contract with Braun & Butler to support County personnel in maintenance of critical systems with the Justice Center. The balance of \$115,153 is to be returned to reserves. Cost:\$0 **Speaker: Judge Schawe/Larry Roberson. Backup:1.**
- 2015.01.20.14** **Discussion/Action** to consider approval of payment for Tracy Bratton, P.E. with Bowman Consulting to address issues concerning adopted subdivision regulations with our Caldwell County Development Ordinance. Cost: Not to exceed \$350.00 for two hours of service. **Speaker: Commissioner Roland/Kasi Miles. Backup:0.**
- 2015.01.20.15** **Discussion/Action** to discuss closure of County Clerk's Office during the lunch hour of 12:00 noon to 01:00pm. **Speaker: Commissioner Moses. Backup:1.**
- 2015.01.20.16** **Discussion/Action** concerning the Burn Ban for Caldwell County. Cost:\$0 **Speaker: Judge Schawe/Martin Ritchey. Backup: 0**
- 2015.01.20.17** **Discussion/Action** to approve a Public Hearing regarding a petition for creation of Emergency Services District #4 for Mid-County Volunteer Fire Department and to set a public hearing date. Cost:TBD. **Speaker: Judge Schawe/Martin Ritchey. Backup:1**
- 2015.01.20.18** **Adjournment.**

As authorized by Chapter 551 of the Texas Government Code, the Commissioners' Court of Caldwell, County, Texas reserves the right to adjourn into Executive Session at any time during the course of this meeting to discuss any of the matters listed above as they may relate to Texas Government Code Section 551.071(1) (Consultation with Attorney about pending or contemplated litigation or settlement offers);

Texas Government Code Section 551.071(2) (Consultation with Attorney when the Attorney's obligations under the Texas Disciplinary Rules of Professional Conduct of the State Bar of Texas conflicts with Chapter 551 of the Texas Government Code);

Texas Government Code Section 551.072 (Deliberations about Real Property); Texas Government Code Section 551.073 (Deliberations about Gifts and Donations); Texas Government Code Section 551.074 (Personnel Matters); Texas Government Code Section 551.0745 (Deliberations about a County Advisory Body); Texas Government Code Section 551.076 (Deliberations about Security Devices); and Texas Government Code Section 551.087 (Economic Development Negotiations).

In the event that the Court adjourns into Executive Session, unless otherwise specified on the agenda, the Court will announce any other parties who are authorized to be present during the deliberations in Executive Session and will announce under what section of the Texas Government Code the Commissioner's Court is using as it's authority to enter into an Executive Session. The meeting facility is wheelchair accessible and accessible parking spaces are available. Request for accommodations or interpretive services must be made 48 hours prior to this meeting. Please contact the County Judge's office at 512-398-1808 for further information.

**Invocation – Lockhart Ministry
Alliance**

Pledge of Allegiance to the Flag.

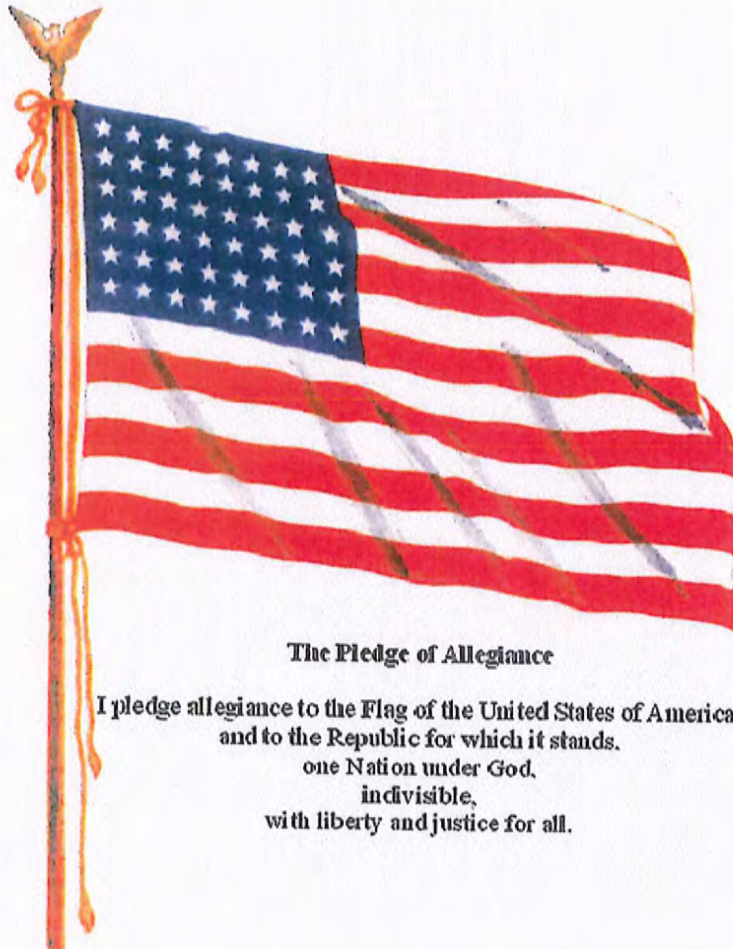

The Pledge of Allegiance

**I pledge allegiance to the Flag of the United States of America,
and to the Republic for which it stands,
one Nation under God,
indivisible,
with liberty and justice for all.**

**(Texas Pledge: Honor the Texas flag;
I pledge allegiance to thee, Texas,
one state under God, one and
indivisible).**

Pledge to the Texas Flag



Honor the Texas
Flag; I pledge
allegiance to thee,
Texas, one state
under God, one and
indivisible

Announcements:

**Items or comments from Court
Members or Staff.**

Citizens' Comments:

At this time any person may speak to Commissioners Court if they have filled out a Caldwell County Commissioners Court Participation Form. Comments will be limited to four (4) minutes per person. No action will be taken on these items and no discussion will be had between the speaker(s) and members of the Court. The Court does retain the right to correct factual inaccuracies made by the speakers. (If longer than 30 minutes, then the balance of comment will continue as the last agenda item of the day).

2015.01.20.05 Consent Agenda. (Any member of the Court may request that an item within the Consent Agenda to be moved to the Regular Agenda for further discussion and action).

A.



A Proclamation

Whereas, Caldwell County recognizes the outstanding achievements of notable individuals and celebrates their contributions to the community; so it is with Fire Chief Jerry Doyle; and

Whereas, Chief Jerry Doyle is set to retire after forty-three years of service to the people of Caldwell County; and

Whereas, Chief Jerry Doyle has been an active member of the Texas Fire Chiefs Association, the Caldwell County Fire Chiefs Association, the State Firefighters and Fire Marshals Association and the International Association of Fire Chiefs; and

Whereas, Chief Jerry Doyle has attained the highest levels of firefighting certifications and is a licensed Peace Officer; and

Whereas, Chief Jerry Doyle served concurrently as Fire Chief of the City of Lockhart and as Volunteer Fire Chief for Mid-County Volunteer Fire Department where he was the founding Chief Officer;

Now, Therefore Be It Resolved, that Chief Jerry Doyle be recognized by this Proclamation as an outstanding individual and applauded for his efforts.

Adopted on this 20th day of January 2015

Ken Schawe, County Judge

Alfredo R. Muñoz, Commissioner Precinct 1

Eddie Moses, Commissioner Precinct 2

Neto Madrigal, Commissioner Precinct 3

Joe I. Roland, Commissioner Precinct 4

2015.01.20.06 Reports.

Unit Road Systems Report – Dwight Jeffrey
Maintenance Report – Curtis Weber

Acknowledge receipt of Federal Inmate
Report, General Fund Report, Tax
Collection Report from County Auditor,
Larry Roberson.

Elizabeth Larivee

From: Marie Cavanagh <marie.cavanagh@co.caldwell.tx.us>
Sent: Wednesday, January 14, 2015 10:29 AM
To: elizabeth.larivee@co.caldwell.tx.us
Subject: FW: Nov,Dec. reports

From: Curtis Weber [<mailto:curtis.weber@co.caldwell.tx.us>]
Sent: Wednesday, January 14, 2015 10:27 AM
To: Marie Cavanagh
Cc: j.roland60@yahoo.com
Subject: Nov,Dec. reports

Maintenance Report

In November the maintenance department completed 3 electrical , 15 air-condition, 2 plumbing, 9 building maintenance, 4 moving, 4 landscaping, and 36 miscellaneous work orders.

In December the maintenance department completed 4 electrical,8 air-condition, 11 plumbing, 1 building maintenance,14 moving, 1 landscaping, and 74 miscellaneous work orders.

Thanks
Curtis Weber
405 Market. St.
Lockhart Tx,78644
Cell 512-738-1508
Fax 512-398=1837
curtis.weber@co.caldwell.tx.us

Service Request / Work Order History
(Pending and Completed by Location)

Assignment: All
12/1/2014 - 12/31/2014
All Types of Work
All Locations in All Areas

Caldwell County

Precinct 1: County Roads

Location	WO Date	WO#	Type of Work	Caller / Source	Completed
CR 197 YOUNG LN	12/9 /2014	1299	Patch road surface	Edward Perez	12/10/2014

Precinct 2: County Roads

Location	WO Date	WO#	Type of Work	Caller / Source	Completed
CR 135B FAR SOUTH DR	12/4 /2014	1293	Blade surface	Curtis Weber	12/9/2014
CR 158 TAYLORSVILLE RD (FM 86 to FM 713)	12/9 /2014	1300	Patch road surface	Leroy Wilhelm	1/12/2015
CR 159 PETTYTOWN RD (FM 86 to County Line)	12/8 /2014	1297	Blade surface	Jennifer Beck	12/11/2014
	12/8 /2014	1298	Other sign work	Jennifer Beck	12/11/2014
	12/11/2014	1302	Repair driveway entrance 12-15 -Per DKJ-they buy 18x24 A - county will install	Pete Juarez	12/15/2014

Precinct 3: County Roads

Location	WO Date	WO#	Type of Work	Caller / Source	Completed
CR 111 POLITICAL RD (Dead End)	12/10/2014	1301	Blade surface		12/12/2014
CR 226 HOBBY HORSE RD	12/4 /2014	1295	Put up 'Children At Play' sign	Susan Reeves	12/10/2014

Precinct 4: County Roads

Location	WO Date	WO#	Type of Work	Caller / Source	Completed
CR 179 HOMANNVILLE TR (FM 1185 to Hwy. 183)	12/1 /2014	1292	Blade surface	Robert White	12/2/2014
CR 182 DRY CREEK RD (Gravel to CR 183)	12/4 /2014	1294	Blade surface 12-5-Rd not bad-will blade when in area	Ms. Ms. Mrs. Cavaness	12/5/2014
CR 256 CAT BRANCH RD	12/8 /2014	1296	Blade surface 12-9 Per T-will blade when in area- He will patch on CR 166 (TxDot area)	Michael Brooks	12/9/2014

Service Request / Work Order History
(Pending and Completed by Location)

Assignment: All

12/1/2014 - 12/31/2014

All Types of Work

All Locations in All Areas

Caldwell County

Precinct 4: County Roads

Location	WO Date	WO#	Type of Work	Caller / Source	Completed
----------	---------	-----	--------------	-----------------	-----------

Daily Work History & Materials Used

Period: 12/1/2014 - 12/31/2014

(By Location)

All Assignments

Work: All categories and types

Caldwell County

Work done in Area: Precinct 1

CR 81 BRANDING CHASE LN

Date	Work Done	R&B Material Used	Amount Used	Expense
12/3/2014	Mowed grass (0.2 miles)			

CR 108 BORCHERT LP

Date	Work Done	R&B Material Used	Amount Used	Expense
12/16/2014	Installed 6' post w/reflector	#30147 - Yellow Delineator - 4x4	2 each	\$3.40
		#30920 - 6' Green Delineator Post	2 each	\$13.96
12/17/2014	Mowed grass (2.8 miles)			
			Location Total =	\$17.36

CR 109 BLACK ANKLE RD (From CR 107 to CR 108)

Date	Work Done	R&B Material Used	Amount Used	Expense
12/16/2014	Installed 6' post w/reflector	#30147 - Yellow Delineator - 4x4	1 each	\$1.70
		#30920 - 6' Green Delineator Post	1 each	\$6.98
12/17/2014	Mowed grass (1.3 miles)			
			Location Total =	\$8.68

CR 114A TULIP TR

Date	Work Done	R&B Material Used	Amount Used	Expense
12/19/2014	Installed "County Maint. Ends" sign	#30901 - 10' Green U-Channel Post	1 each	\$19.59
		County Maint. Ends (24x18)	1 each	\$23.50
			Location Total =	\$43.09

CR 186 OLD KELLEY RD (CR 185 to E.FM 20)

Date	Work Done	R&B Material Used	Amount Used	Expense
12/3/2014	Mowed grass (1 mile)			

CR 196 BROWNSBORO LN (From FM 1322 to CR 205)

Date	Work Done	R&B Material Used	Amount Used	Expense
12/3/2014	Bladed surface (0.6 miles)			

Daily Work History & Materials Used

Period: 12/1/2014 - 12/31/2014

(By Location)

All Assignments

Work: All categories and types

Caldwell County

Work done in Area: Precinct 1

CR 196 BROWNSBORO LN (From FM 1322 to CR 205)

Date	Work Done	R&B Material Used	Amount Used	Expense
------	-----------	-------------------	-------------	---------

CR 197 YOUNG LN

Date	Work Done	R&B Material Used	Amount Used	Expense
------	-----------	-------------------	-------------	---------

12/1/2014	Bladed surface (0.1 miles)			
-----------	----------------------------	--	--	--

12/10/2014	Patched road surface (0.3 miles) (Type D - 5 T)	Type D Cold Mix	5 ton(s)	\$325.00
------------	---	-----------------	----------	----------

	Location Total =		\$325.00
--	------------------	--	----------

CR 200 WELLS RD

Date	Work Done	R&B Material Used	Amount Used	Expense
------	-----------	-------------------	-------------	---------

12/1/2014	Bladed surface (1.1 miles)			
-----------	----------------------------	--	--	--

12/17/2014	Patched road surface (0.2 miles) (Type D - 8 T)	Type D Cold Mix	8 ton(s)	\$520.00
------------	---	-----------------	----------	----------

	Location Total =		\$520.00
--	------------------	--	----------

CR 201 CATTLEMENS ROW (FM 713 to dead end)

Date	Work Done	R&B Material Used	Amount Used	Expense
------	-----------	-------------------	-------------	---------

12/1/2014	Bladed surface (0.8 miles)			
-----------	----------------------------	--	--	--

12/30/2014	Bladed surface (0.8 miles) (Spot Bladed)			
------------	--	--	--	--

CR 202 OLD MCMAHAN RD (C/L to FM 713)

Date	Work Done	R&B Material Used	Amount Used	Expense
------	-----------	-------------------	-------------	---------

12/11/2014	Replaced 10' post			
------------	-------------------	--	--	--

12/30/2014	Re-Installed 10' post	#30901 - 10' Green U-Channel Post	1 each	\$19.59
------------	-----------------------	-----------------------------------	--------	---------

	Bladed surface (1.3 miles) (Spot bladed)			
--	--	--	--	--

	Location Total =		\$19.59
--	------------------	--	---------

CR 204 STAR RD

Date	Work Done	R&B Material Used	Amount Used	Expense
------	-----------	-------------------	-------------	---------

12/30/2014	Bladed surface (1 mile)			
------------	-------------------------	--	--	--

Daily Work History & Materials Used

Period: 12/1/2014 - 12/31/2014

(By Location)

All Assignments

Work: All categories and types

Caldwell County

Work done in Area: Precinct 1

CR 205 SEAWILLOW RD (From No. FM 1322 to CR 197)

Date	Work Done	R&B Material Used	Amount Used	Expense
12/10/2014	Patched road surface (4.5 miles) (Type D - 2 T)	Type D Cold Mix	2 ton(s)	\$130.00
			Location Total =	\$130.00

CR 208 SOUTH LANE

Date	Work Done	R&B Material Used	Amount Used	Expense
12/3/2014	Bladed surface (0.8 miles)			
12/9/2014	Bladed surface; added base (0.1 miles) (3/4" Base - 24 T)	3/4" base to dust	24 ton(s)	\$347.28
12/10/2014	Bladed surface; added base (0.1 miles) (3/4" base - 120 T)	3/4" base to dust	120 ton(s)	\$1,736.40
			Location Total =	\$2,083.68

CR 209 BRUSHY BRANCH RD

Date	Work Done	R&B Material Used	Amount Used	Expense
12/3/2014	Bladed surface (1.2 miles)			
12/29/2014	Bladed surface (1.2 miles) (Spot bladed)			

CR 210 BRITE RD (E.FM 20 to CR 186)

Date	Work Done	R&B Material Used	Amount Used	Expense
12/3/2014	Mowed grass (0.2 miles)			

CR 212 REAVIS RD

Date	Work Done	R&B Material Used	Amount Used	Expense
12/2/2014	Bladed surface (1.1 miles)			
12/29/2014	Bladed surface (1.1 miles)			

CR 214 GRAHAM RD

Date	Work Done	R&B Material Used	Amount Used	Expense
12/2/2014	Bladed surface (0.6 miles)			

Daily Work History & Materials Used

Period: 12/1/2014 - 12/31/2014

(By Location)

All Assignments

Work: All categories and types

Caldwell County

Work done in Area: Precinct 1

CR 214 GRAHAM RD

Date	Work Done	R&B Material Used	Amount Used	Expense
12/8/2014	Bladed surface; added base (0.1 miles) (3/4" base - 48 T)	3/4" base to dust	48 ton(s)	\$694.56
12/9/2014	Bladed surface; added base (0.1 miles) (3/4" Base - 48 T)	3/4" base to dust	48 ton(s)	\$694.56
			Location Total =	\$1,389.12

CR 215 WESTWOOD RD

Date	Work Done	R&B Material Used	Amount Used	Expense
12/29/2014	Bladed surface (2.1 miles)			

CR 234 CYPRESS RD

Date	Work Done	R&B Material Used	Amount Used	Expense
12/1/2014	Mowed grass (1.2 miles)			

CR 235A COUNTY LN

Date	Work Done	R&B Material Used	Amount Used	Expense
12/1/2014	Mowed grass (0.1 miles)			

CR 235 COUNTY VIEW RD (FM 2720 to Dead End)

Date	Work Done	R&B Material Used	Amount Used	Expense
12/1/2014	Mowed grass (6 miles)			
	Bladed surface; Added millings (0.1 miles) (Milling - 60 T)	Milling	60 ton(s)	\$1,800.00
12/2/2014	Bladed surface; Added millings (0.1 miles) (Milling - 36 T; Base - 12 T)	3/4" base to dust	12 ton(s)	\$173.64
		Milling	36 ton(s)	\$1,080.00
			Location Total =	\$3,053.64

CR 236 PAYNE LN

Date	Work Done	R&B Material Used	Amount Used	Expense
12/1/2014	Mowed grass (0.4 miles)			

Daily Work History & Materials Used

Period: 12/1/2014 - 12/31/2014

(By Location)

All Assignments

Work: All categories and types

Caldwell County

Work done in Area: Precinct 1

CR 236 PAYNE LN

Date	Work Done	R&B Material Used	Amount Used	Expense
------	-----------	-------------------	-------------	---------

CR 237 CLARK LP

Date	Work Done	R&B Material Used	Amount Used	Expense
------	-----------	-------------------	-------------	---------

12/17/2014	Mowed grass (1.1 miles)			
------------	-------------------------	--	--	--

Material Total for this Area = \$7,590.16

Daily Work History & Materials Used

Period: 12/1/2014 - 12/31/2014

(By Location)

All Assignments

Work: All categories and types

Caldwell County

Work done in Area: Precinct 2

CR 83 TRAILSIDE DR

Date	Work Done	R&B Material Used	Amount Used	Expense
12/3/2014	Mowed grass (0.2 miles)			

CR 90 PEBBLESTONE RD

Date	Work Done	R&B Material Used	Amount Used	Expense
12/10/2014	Replaced one 10' post			

CR 105 RIVER PARK RD

Date	Work Done	R&B Material Used	Amount Used	Expense
12/1/2014	Bladed surface (2.3 miles)			

CR 112A STUBBY RD

Date	Work Done	R&B Material Used	Amount Used	Expense
12/1/2014	Bladed surface (0.5 miles)			

CR 115 BUGTUSSLE LANE (FM 671 to CR 112)

Date	Work Done	R&B Material Used	Amount Used	Expense
12/2/2014	Bladed surface (2 miles)			

CR 115 WASHBURN RD (FM 2984 to FM 671)

Date	Work Done	R&B Material Used	Amount Used	Expense
12/11/2014	Hauled off brush			

CR 116 PLANT RD (Hwy. 80 to CR 115)

Date	Work Done	R&B Material Used	Amount Used	Expense
12/3/2014	Bladed surface (2.7 miles)			
12/11/2014	Patched road surface (0.9 miles) (Type D - 2 T) Hauled off brush	Type D Cold Mix	2 ton(s)	\$130.00

Daily Work History & Materials Used

Period: 12/1/2014 - 12/31/2014

(By Location)

All Assignments

Work: All categories and types

Caldwell County

Work done in Area: Precinct 2

CR 116 PLANT RD (Hwy. 80 to CR 115)

Date	Work Done	R&B Material Used	Amount Used	Expense
12/19/2014	Put up "Bridge Markers"	#30901 - 10' Green U-Channel Post	1 each	\$19.59
		#OM-3L - Left Bridge Marker	1 each	\$23.25
		#OM-3R - Right Bridge Marker	1 each	\$23.25
			Location Total =	\$196.09

CR 116 PLANT RD (Hwy. 80 to River)

Date	Work Done	R&B Material Used	Amount Used	Expense
12/11/2014	Hauled off brush			

CR 117 MERIDIAN LN

Date	Work Done	R&B Material Used	Amount Used	Expense
12/11/2014	Patched road surface (0.9 miles) (Type D - 3 T)	Type D Cold Mix	3 ton(s)	\$195.00
	Hauled off hottub			
			Location Total =	\$195.00

CR 118 STAIRTOWN LOOP (Hwy. 80 to CR 116)

Date	Work Done	R&B Material Used	Amount Used	Expense
12/16/2014	Patched road surface (Type D - 1 T - Off Hwy. 80 - TXDOT)	Type D Cold Mix	1 ton(s)	\$65.00
			Location Total =	\$65.00

CR 119 STAIRTOWN RD

Date	Work Done	R&B Material Used	Amount Used	Expense
12/11/2014	Patched road surface (0.4 miles) (Type D - 2 T)	Type D Cold Mix	2 ton(s)	\$130.00
12/16/2014	Patched road surface (0.2 miles) (Type D - 2 T)	Type D Cold Mix	2 ton(s)	\$130.00
			Location Total =	\$260.00

CR 120 PECAN CT.

Date	Work Done	R&B Material Used	Amount Used	Expense
12/16/2014	Patched road surface (0.2 miles) (Type D - 1 T)	Type D Cold Mix	1 ton(s)	\$65.00
			Location Total =	\$65.00

Daily Work History & Materials Used

Period: 12/1/2014 - 12/31/2014

(By Location)

All Assignments

Work: All categories and types

Caldwell County

Work done in Area: Precinct 2

CR 122 AUSTIN RD

Date	Work Done	R&B Material Used	Amount Used	Expense
12/16/2014	Patched road surface (0.8 miles) (Type D - 3 T)	Type D Cold Mix	3 ton(s)	\$195.00
			Location Total =	\$195.00

CR 127 OAK GROVE RD

Date	Work Done	R&B Material Used	Amount Used	Expense
12/19/2014	Put up 'Speed Limit' sign (2) 20mph	#W13-1-20 - "20 MPH" (Y/B) - (18x18)	2 each	\$28.58
			Location Total =	\$28.58

CR 128 SALT FLAT RD

Date	Work Done	R&B Material Used	Amount Used	Expense
12/19/2014	Hauled off brush			
12/22/2014	Bladed surface; added base (3.1 miles) (3/4" Base - 96 T)	3/4" base to dust	96 ton(s)	\$1,389.12
			Location Total =	\$1,389.12

CR 129 PUMPER RD

Date	Work Done	R&B Material Used	Amount Used	Expense
12/11/2014	Put up COUNTY road name sign (@ FM 86)	#30901 - 10' Green U-Channel Post	1 each	\$19.59
		County Road Name Sign	2 each	\$13.90
	Put up COUNTY road name sign (@ CR 128)	County Road Name Sign	2 each	\$13.90
			Location Total =	\$47.39

CR 131 BIGGS RD

Date	Work Done	R&B Material Used	Amount Used	Expense
12/29/2014	Bladed surface (2.7 miles)			

CR 133 IVY SWITCH RD

Date	Work Done	R&B Material Used	Amount Used	Expense
12/11/2014	Bladed surface (1.6 miles)			

Daily Work History & Materials Used

Period: 12/1/2014 - 12/31/2014

(By Location)

All Assignments

Work: All categories and types

Caldwell County

Work done in Area: Precinct 2

CR 134 MULECREEK RD (CR 133 to Gonzales Cty Line)

Date	Work Done	R&B Material Used	Amount Used	Expense
12/10/2014	Bladed surface; added base (1.5 miles) (3/4" base - 60 T)	3/4" base to dust	60 ton(s)	\$868.20
12/15/2014	Bladed surface (1.5 miles)			
			Location Total =	\$868.20

CR 135B FAR SOUTH DR

Date	Work Done	R&B Material Used	Amount Used	Expense
12/9/2014	Bladed surface; added base (0.4 miles) (3/4" base - 48 T)	3/4" base to dust	48 ton(s)	\$694.56
			Location Total =	\$694.56

CR 135A SOUTHERN WAY

Date	Work Done	R&B Material Used	Amount Used	Expense
12/8/2014	Bladed surface (0.4 miles)			

CR 135 WHISPER RD

Date	Work Done	R&B Material Used	Amount Used	Expense
12/5/2014	Trimmed brush or trees (0.5 miles)			
12/9/2014	Trimmed brush or trees (1 mile)			

CR 140 WATTSVILLE RD

Date	Work Done	R&B Material Used	Amount Used	Expense
12/11/2014	Put up 'Speed Limit' sign	#R2-1-30 - Speed Limit 30 - (18x24)	1 each	\$23.25
			Location Total =	\$23.25

CR 141 TENNEY CREEK RD

Date	Work Done	R&B Material Used	Amount Used	Expense
12/5/2014	Bladed surface (3 miles) (From FM 86)			

Daily Work History & Materials Used

Period: 12/1/2014 - 12/31/2014

(By Location)

All Assignments

Work: All categories and types

Caldwell County

Work done in Area: Precinct 2

CR 143 CHUCKWAGON RD

Date	Work Done	R&B Material Used	Amount Used	Expense
12/8/2014	Bladed surface (3.5 miles)			

CR 145A BLOSSOM CT

Date	Work Done	R&B Material Used	Amount Used	Expense
12/16/2014	Bladed surface (1 mile)			

CR 145B VINE HILL RD

Date	Work Done	R&B Material Used	Amount Used	Expense
12/17/2014	Bladed surface (0.3 miles)			

CR 147 SPARROW TR

Date	Work Done	R&B Material Used	Amount Used	Expense
12/8/2014	Bladed surface (0.7 miles)			

CR 150 KIRK CORNERS

Date	Work Done	R&B Material Used	Amount Used	Expense
12/2/2014	Hauled off brush			
12/8/2014	Bladed surface (1 mile)			
12/15/2014	Trimmed brush or trees (0.5 miles)			
12/18/2014	Trimmed brush or trees (0.5 miles)			

CR 151A BUCK BRANCH RD

Date	Work Done	R&B Material Used	Amount Used	Expense
12/11/2014	Patched road surface (Type D - 2 T)	Type D Cold Mix	2 ton(s)	\$130.00
			Location Total =	\$130.00

Daily Work History & Materials Used

Period: 12/1/2014 - 12/31/2014

(By Location)

All Assignments

Work: All categories and types

Caldwell County

Work done in Area: Precinct 2

CR 151 SANDY FORK RD

Date	Work Done	R&B Material Used	Amount Used	Expense
12/11/2014	Put up COUNTY road name sign (@ Hwy. 304)	#30901 - 10' Green U-Channel Post	1 each	\$19.59
		County Road Name Sign	2 each	\$13.90
			Location Total =	\$33.49

CR 152 CHALK RD

Date	Work Done	R&B Material Used	Amount Used	Expense
12/1/2014	Hauled off brush (4 miles)			
12/5/2014	Bladed surface (2 miles)			

CR 155A BLUE JAY RD

Date	Work Done	R&B Material Used	Amount Used	Expense
12/3/2014	Bladed surface; added base (1.4 miles) (3/4" base - 96 T)	3/4" base to dust	96 ton(s)	\$1,389.12
12/5/2014	Bladed surface (1.4 miles)			
			Location Total =	\$1,389.12

CR 158 TAYLORSVILLE RD (E. FM 20 to FM 86)

Date	Work Done	R&B Material Used	Amount Used	Expense
12/18/2014	Trimmed brush or trees (by hand)			

CR 158 TAYLORSVILLE RD (FM 86 to FM 713)

Date	Work Done	R&B Material Used	Amount Used	Expense
12/23/2014	Put up 'Stop' sign @ Pettytown Rd	#R1-1-30 - "Stop Sign" - 30"	1 each	\$38.00
	Put up PRIVATE road name sign @ Wagon Rd	County Road Name Sign	1 each	\$6.95
		Private Road Name Sign	1 each	\$0.00
			Location Total =	\$44.95

CR 159 PETTYTOWN RD (FM 86 to County Line)

Date	Work Done	R&B Material Used	Amount Used	Expense
12/11/2014	Installed "Burn Ban" sign	Burn Ban Signs	1 each	\$0.00
	Patched road surface (Type D - 3 T)	Type D Cold Mix	3 ton(s)	\$195.00

Daily Work History & Materials Used

Period: 12/1/2014 - 12/31/2014

(By Location)

All Assignments

Work: All categories and types

Caldwell County

Work done in Area: Precinct 2

CR 159 PETTYTOWN RD (FM 86 to County Line)

Date	Work Done	R&B Material Used	Amount Used	Expense
			Location Total =	\$195.00

CR 161 SAND HILL RD

Date	Work Done	R&B Material Used	Amount Used	Expense
12/11/2014	Patched road surface (Type D - 2 T)	Type D Cold Mix	2 ton(s)	\$130.00
			Location Total =	\$130.00

CR 201 CATTLEMENS ROW (FM 713 to CR 202)

Date	Work Done	R&B Material Used	Amount Used	Expense
12/1/2014	Bladed surface (0.3 miles)			
12/11/2014	Put up 'Stop' sign	"3-Way" Stop Signs	1 each	\$4.95
12/19/2014	Put up 'Stop' sign	#30901 - 10' Green U-Channel Post	1 each	\$19.59
		#R1-1-30 - "Stop Sign" - 30"	1 each	\$38.00
			Location Total =	\$62.54

CR 201 CATTLEMENS ROW (CR 202 to CR 210)

Date	Work Done	R&B Material Used	Amount Used	Expense
12/2/2014	Bladed surface (1.8 miles)			
12/30/2014	Bladed surface (1.8 miles) (Spot bladed)			

CR 210 BRITE RD. (E, FM 20 to FM 713)

Date	Work Done	R&B Material Used	Amount Used	Expense
12/1/2014	Bladed surface (0.6 miles)			
12/30/2014	Bladed surface (0.6 miles) (Spot bladed)			

CR 247 ST. JOSEPH ST

Date	Work Done	R&B Material Used	Amount Used	Expense
12/10/2014	Patched road surface (1.3 miles) (Type D - 1 T)	Type D Cold Mix	1 ton(s)	\$65.00
12/11/2014	Hauled off brush			
12/22/2014	Trimmed brush or trees (0.6 miles)			

Daily Work History & Materials Used

Period: 12/1/2014 - 12/31/2014

(By Location)

All Assignments

Work: All categories and types

Caldwell County

Work done in Area: Precinct 2

CR 247 ST. JOSEPH ST

Date	Work Done	R&B Material Used	Amount Used	Expense
			Location Total =	\$65.00

CR 248 TREETOP LANE

Date	Work Done	R&B Material Used	Amount Used	Expense
12/16/2014	Patched road surface (0.4 miles) (Type D - 2 T)	Type D Cold Mix	2 ton(s)	\$130.00
			Location Total =	\$130.00

CR 249 SANDY PINE RD

Date	Work Done	R&B Material Used	Amount Used	Expense
12/4/2014	Trimmed brush or trees (0.6 miles)			

CR 251 TURKEY HOLLOW RD

Date	Work Done	R&B Material Used	Amount Used	Expense
12/15/2014	Bladed surface (1 mile) (Hwy. 90 to CR 249)			

CR 254 MOLASSES RD

Date	Work Done	R&B Material Used	Amount Used	Expense
12/18/2014	Cleared debris or fallen tree			
12/29/2014	Bladed surface; added base (0.1 miles) (3/4" base - 96 T.)	3/4" base to dust	96 ton(s)	\$1,389.12
12/30/2014	Bladed surface; added base (0.1 miles) (3/4" Base - 228 T.)	3/4" base to dust	228 ton(s)	\$3,299.16
			Location Total =	\$4,688.28

CR 283 MARKET ST

Date	Work Done	R&B Material Used	Amount Used	Expense
12/11/2014	Hauled off brush			

CR 299 YELLOWSTONE RD.

Date	Work Done	R&B Material Used	Amount Used	Expense
------	-----------	-------------------	-------------	---------

Daily Work History & Materials Used

Period: 12/1/2014 - 12/31/2014

(By Location)

All Assignments

Work: All categories and types

Caldwell County

Work done in Area: Precinct 2

CR 299 YELLOWSTONE RD.

Date	Work Done	R&B Material Used	Amount Used	Expense
12/16/2014	Patched road surface (0.1 miles) (Type D - 1 T)	Type D Cold Mix	1 ton(s)	\$65.00
			Location Total =	\$65.00

CR 305 REED CREEK DR

Date	Work Done	R&B Material Used	Amount Used	Expense
12/2/2014	Bladed surface; added base (1.8 miles) 3/4" base - 120 T	3/4" base to dust	120 ton(s)	\$1,736.40
12/16/2014	Cleaned fence			
			Location Total =	\$1,736.40

CR 306 CLEAR CREEK RD

Date	Work Done	R&B Material Used	Amount Used	Expense
12/8/2014	Bladed surface (0.2 miles)			

CR 313 BOULDER LN

Date	Work Done	R&B Material Used	Amount Used	Expense
12/16/2014	Bladed surface (1.6 miles)			

Material Total for this Area = \$12,696.97

Daily Work History & Materials Used

Period: 12/1/2014 - 12/31/2014

(By Location)

All Assignments

Work: All categories and types

Caldwell County

Work done in Area: Precinct 3

MUSTANG HOLLOW LP

Date	Work Done	R&B Material Used	Amount Used	Expense
12/10/2014	Mowed grass (1.8 miles)			

CR 36 GARRETT TR

Date	Work Done	R&B Material Used	Amount Used	Expense
12/5/2014	Mowed grass (1.1 miles)			

CR 37 CITY VIEW DR

Date	Work Done	R&B Material Used	Amount Used	Expense
12/5/2014	Mowed grass (0.4 miles)			

CR 38 KOEGLER DR

Date	Work Done	R&B Material Used	Amount Used	Expense
12/5/2014	Mowed grass (0.4 miles)			
12/19/2014	Put up COUNTY road name sign (@ CR 39)	County Road Name Sign	2 each	\$13.90
			Location Total =	\$13.90

CR 39 COTTONFIELD DR

Date	Work Done	R&B Material Used	Amount Used	Expense
12/5/2014	Mowed grass (0.2 miles)			

CR 59 DOVE HILL CT

Date	Work Done	R&B Material Used	Amount Used	Expense
12/3/2014	Mowed grass (0.1 miles)			

CR 60 NIEDERWALD DR

Date	Work Done	R&B Material Used	Amount Used	Expense
12/3/2014	Mowed grass (0.2 miles)			

Daily Work History & Materials Used

Period: 12/1/2014 - 12/31/2014

(By Location)

All Assignments

Work: All categories and types

Caldwell County

Work done in Area: Precinct 3

CR 60 NIEDERWALD DR

Date	Work Done	R&B Material Used	Amount Used	Expense
------	-----------	-------------------	-------------	---------

CR 61 DOVE HILL DR

Date	Work Done	R&B Material Used	Amount Used	Expense
------	-----------	-------------------	-------------	---------

12/3/2014	Mowed grass (0.5 miles)			
-----------	-------------------------	--	--	--

CR 62 FOXHOLLOW RD

Date	Work Done	R&B Material Used	Amount Used	Expense
------	-----------	-------------------	-------------	---------

12/3/2014	Mowed grass (0.3 miles)			
-----------	-------------------------	--	--	--

CR 63 RANCHERO DR

Date	Work Done	R&B Material Used	Amount Used	Expense
------	-----------	-------------------	-------------	---------

12/3/2014	Mowed grass (0.3 miles)			
-----------	-------------------------	--	--	--

CR 64 SUNDANCE CT

Date	Work Done	R&B Material Used	Amount Used	Expense
------	-----------	-------------------	-------------	---------

12/1/2014	Mowed grass (0.1 miles)			
-----------	-------------------------	--	--	--

CR 66 HUMPHREY CT

Date	Work Done	R&B Material Used	Amount Used	Expense
------	-----------	-------------------	-------------	---------

12/15/2014	Mowed grass (0.2 miles)			
------------	-------------------------	--	--	--

CR 67 BIRCH ST

Date	Work Done	R&B Material Used	Amount Used	Expense
------	-----------	-------------------	-------------	---------

12/4/2014	Patched road surface (0.2 miles) (Type D - 1 T)	Type D Cold Mix	1 ton(s)	\$65.00
-----------	---	-----------------	----------	---------

12/12/2014	Mowed grass (0.2 miles)			
------------	-------------------------	--	--	--

Location Total = \$65.00

Daily Work History & Materials Used

Period: 12/1/2014 - 12/31/2014

(By Location)

All Assignments

Work: All categories and types

Caldwell County

Work done in Area: Precinct 3

CR 68 ASPEN RD.

Date	Work Done	R&B Material Used	Amount Used	Expense
12/4/2014	Patched road surface (0.3 miles) (Type D - 1 T)	Type D Cold Mix	1 ton(s)	\$65.00
12/12/2014	Mowed grass (0.2 miles)			
			Location Total =	\$65.00

CR 101 OLD BASTROP RD (Hwy. 80 to River)

Date	Work Done	R&B Material Used	Amount Used	Expense
12/12/2014	Mowed grass (1 mile)			

CR 101 OLD BASTROP RD. (Hwy. 80 to Hwy.21)

Date	Work Done	R&B Material Used	Amount Used	Expense
12/12/2014	Mowed grass (0.8 miles)			

CR 102 MARTINDALE RD

Date	Work Done	R&B Material Used	Amount Used	Expense
12/4/2014	Patched road surface (1 mile) (Type D - 4 T)	Type D Cold Mix	4 ton(s)	\$260.00
12/12/2014	Mowed grass (1 mile)			
			Location Total =	\$260.00

CR 103 S.E. RIVER RD

Date	Work Done	R&B Material Used	Amount Used	Expense
12/5/2014	Patched road surface (2.2 miles) (Type D - 6 T)	Type D Cold Mix	6 ton(s)	\$390.00
12/15/2014	Mowed grass (1.1 miles)			
12/30/2014	Re-Installed 10' Post(s) and curve sign	#30901 - 10' Green U-Channel Post	4 each	\$78.36
		#W1-2R - Right Curve Arrow - (24x24)	1 each	\$31.00
			Location Total =	\$499.36

CR 103A SPRING RIVER DR

Date	Work Done	R&B Material Used	Amount Used	Expense
12/12/2014	Mowed grass (0.6 miles)			

Daily Work History & Materials Used

Period: 12/1/2014 - 12/31/2014

(By Location)

All Assignments

Work: All categories and types

Caldwell County

Work done in Area: Precinct 3

CR 106 WEST RIDGE RD

Date	Work Done	R&B Material Used	Amount Used	Expense
12/16/2014	Mowed grass (1.3 miles)			
	Put up 'Children At Play' sign	"Slow Children At Play" W/Symbol (18x24)	1 each	\$23.25
		#30147 - Yellow Delineator - 4x4	6 each	\$10.20
		#30901 - 10' Green U-Channel Post	1 each	\$19.59
		#30920 - 6' Green Delineator Post	4 each	\$27.92
			Location Total =	\$80.96

CR 107 DICKERSON RD

Date	Work Done	R&B Material Used	Amount Used	Expense
12/16/2014	Mowed grass (4.3 miles)			
12/22/2014	Bladed surface (4.3 miles)			

CR 110 LONG RD (CR 109 to I-130 Const.)

Date	Work Done	R&B Material Used	Amount Used	Expense
12/18/2014	Mowed grass (3.6 miles)			

CR 110 LONG RD (Hwy. 80 E. to I-130 Const)

Date	Work Done	R&B Material Used	Amount Used	Expense
12/10/2014	Patched road surface (3/4" Base - 1 T - TXDOT R.O.W.)	Type D Cold Mix	1 ton(s)	\$65.00
			Location Total =	\$65.00

CR 111 POLITICAL RD (Hwy. 80 to W FM 20)

Date	Work Done	R&B Material Used	Amount Used	Expense
12/18/2014	Bladed surface; added base (0.2 miles) (3/4" base - 124 T)	3/4" base to dust	124 ton(s)	\$1,794.28
12/22/2014	Bladed surface (3.9 miles)			
			Location Total =	\$1,794.28

CR 111 POLITICAL RD (Dead End)

Date	Work Done	R&B Material Used	Amount Used	Expense
------	-----------	-------------------	-------------	---------

Daily Work History & Materials Used

Period: 12/1/2014 - 12/31/2014

(By Location)

All Assignments

Work: All categories and types

Caldwell County

Work done in Area: Precinct 3

CR 111 POLITICAL RD (Dead End)

Date	Work Done	R&B Material Used	Amount Used	Expense
12/12/2014	Bladed surface; added base (0.9 miles) (3/4" base - 48 T)	3/4" base to dust	48 ton(s)	\$694.56
12/15/2014	Bladed surface; added base (0.1 miles) (3/4" base - 48 T)	3/4" base to dust	48 ton(s)	\$694.56
12/18/2014	Bladed surface; added base (0.1 miles) (3/4" base - 12 T)	3/4" base to dust	12 ton(s)	\$173.64
			Location Total =	\$1,562.76

CR 112 CALLIHAN RD (From W.FM 20 to CR 115)

Date	Work Done	R&B Material Used	Amount Used	Expense
12/1/2014	Patched road surface (1 mile) (Type D - 3 T)	Type D Cold Mix	3 ton(s)	\$195.00
12/2/2014	Patched road surface (1 mile) (Type D - 3 T.)	Type D Cold Mix	3 ton(s)	\$195.00
12/15/2014	Trimmed brush or trees (1 mile)			
12/16/2014	Installed 6' post w/reflector			
			Location Total =	\$390.00

CR 173 MILL RD

Date	Work Done	R&B Material Used	Amount Used	Expense
12/4/2014	Patched road surface (0.4 miles) (Type D - 2 T)	Type D Cold Mix	2 ton(s)	\$130.00
12/12/2014	Mowed grass (0.4 miles)			
			Location Total =	\$130.00

CR 176 E. LONE STAR DR. (Hwy. 21 to Travis County Line)

Date	Work Done	R&B Material Used	Amount Used	Expense
12/10/2014	Mowed grass (1 mile)			

CR 177 WILLIAMSON RD (Hwy. 21 No.)

Date	Work Done	R&B Material Used	Amount Used	Expense
12/3/2014	Mowed grass (0.2 miles)			

Daily Work History & Materials Used

Period: 12/1/2014 - 12/31/2014

(By Location)

All Assignments

Work: All categories and types

Caldwell County

Work done in Area: Precinct 3

CR 177 WILLIAMSON RD (Hwy. 183 - Hwy. 21)

Date	Work Done	R&B Material Used	Amount Used	Expense
12/3/2014	Mowed grass (0.9 miles)			

CR 179 BRIARPATCH RD

Date	Work Done	R&B Material Used	Amount Used	Expense
12/3/2014	Mowed grass (0.4 miles)			

CR 190 SKYLINE RD

Date	Work Done	R&B Material Used	Amount Used	Expense
12/15/2014	Mowed grass (1.4 miles)			

CR 191 LONGHOLLOW RD

Date	Work Done	R&B Material Used	Amount Used	Expense
12/15/2014	Mowed grass (0.8 miles)			

CR 192 CALDER RD

Date	Work Done	R&B Material Used	Amount Used	Expense
12/15/2014	Mowed grass (1.6 miles)			
12/22/2014	Patched road surface (1.6 miles) (Type D - 2 T)	Type D Cold Mix	2 ton(s)	\$130.00
			Location Total =	\$130.00

CR 193 AVIS RD

Date	Work Done	R&B Material Used	Amount Used	Expense
12/15/2014	Mowed grass (1.1 miles)			
12/22/2014	Patched road surface (1.1 miles) (Type D - 1.5 T)	Type D Cold Mix	1.5 ton(s)	\$97.50
			Location Total =	\$97.50

CR 221 ROLLING RIDGE RD (CR 233 to CR 222)

Date	Work Done	R&B Material Used	Amount Used	Expense
------	-----------	-------------------	-------------	---------

Daily Work History & Materials Used

Period: 12/1/2014 - 12/31/2014

(By Location)

All Assignments

Work: All categories and types

Caldwell County

Work done in Area: Precinct 3

CR 221 ROLLING RIDGE RD (CR 233 to CR 222)

Date	Work Done	R&B Material Used	Amount Used	Expense
12/2/2014	Mowed grass (1.8 miles)			

CR 222 SCHUELKE RD

Date	Work Done	R&B Material Used	Amount Used	Expense
12/2/2014	Mowed grass (3.5 miles)			
12/3/2014	Mowed grass (2 miles)			

CR 223 ROGERS RANCH RD

Date	Work Done	R&B Material Used	Amount Used	Expense
12/4/2014	Mowed grass (2 miles)			

CR 224 HOLZ RD

Date	Work Done	R&B Material Used	Amount Used	Expense
12/4/2014	Mowed grass (1.8 miles)			
	Mowed grass (0.6 miles) (Dead End)			

CR 225 ELM CREEK RD

Date	Work Done	R&B Material Used	Amount Used	Expense
12/1/2014	Mowed grass (1.1 miles)			

CR 226 HOBBY HORSE RD

Date	Work Done	R&B Material Used	Amount Used	Expense
12/1/2014	Mowed grass (0.5 miles)			
12/3/2014	Bladed surface (0.5 miles)			
12/10/2014	Put up 'Children At Play' sign	"Slow Children At Play" W/Symbol (18x24)	3 each	\$69.75
		#30901 - 10' Green U-Channel Post	3 each	\$58.77
12/22/2014	Bladed surface (0.5 miles)			

Daily Work History & Materials Used

Period: 12/1/2014 - 12/31/2014

(By Location)

All Assignments

Work: All categories and types

Caldwell County

Work done in Area: Precinct 3

CR 226 HOBBY HORSE RD

Date	Work Done	R&B Material Used	Amount Used	Expense
			Location Total =	\$128.52

CR 227B FRIAR CT

Date	Work Done	R&B Material Used	Amount Used	Expense
12/4/2014	Mowed grass (0.3 miles)			
12/22/2014	Bladed surface (0.3 miles)			

CR 227A MISSION LN

Date	Work Done	R&B Material Used	Amount Used	Expense
12/4/2014	Mowed grass (0.3 miles)			

CR 227 ROCKY RD

Date	Work Done	R&B Material Used	Amount Used	Expense
12/2/2014	Patched road surface (1.2 miles) (Type D - 5 T)	Type D Cold Mix	5 ton(s)	\$325.00
12/4/2014	Mowed grass (2.2 miles)			
			Location Total =	\$325.00

CR 227 ROCKY RD (Loop)

Date	Work Done	R&B Material Used	Amount Used	Expense
12/4/2014	Mowed grass (0.4 miles)			

CR 228A COTTONWOOD TR

Date	Work Done	R&B Material Used	Amount Used	Expense
12/4/2014	Mowed grass (0.9 miles)			

CR 228 FARMERS RD

Date	Work Done	R&B Material Used	Amount Used	Expense
12/5/2014	Mowed grass (3 miles)			

Daily Work History & Materials Used

Period: 12/1/2014 - 12/31/2014

(By Location)

All Assignments

Work: All categories and types

Caldwell County

Work done in Area: Precinct 3

CR 228 FARMERS RD

Date	Work Done	R&B Material Used	Amount Used	Expense
------	-----------	-------------------	-------------	---------

CR 228 FARMERS RD (LOOP)

Date	Work Done	R&B Material Used	Amount Used	Expense
------	-----------	-------------------	-------------	---------

12/4/2014	Mowed grass (0.3 miles)			
-----------	-------------------------	--	--	--

CR 229 MISTY LN (CR 230 to CR 228)

Date	Work Done	R&B Material Used	Amount Used	Expense
------	-----------	-------------------	-------------	---------

12/3/2014	Bladed surface (3.9 miles)			
-----------	----------------------------	--	--	--

12/8/2014	Mowed grass (3.9 miles)			
-----------	-------------------------	--	--	--

CR 229 MISTY LN, (CR 228 to Hwy. 21)

Date	Work Done	R&B Material Used	Amount Used	Expense
------	-----------	-------------------	-------------	---------

12/5/2014	Mowed grass (1.7 miles)			
-----------	-------------------------	--	--	--

CR 230 JOLLEY RD, (Hwy. 142 to CR 104)

Date	Work Done	R&B Material Used	Amount Used	Expense
------	-----------	-------------------	-------------	---------

12/8/2014	Mowed grass (0.4 miles)			
-----------	-------------------------	--	--	--

CR 231 FIFTH ST

Date	Work Done	R&B Material Used	Amount Used	Expense
------	-----------	-------------------	-------------	---------

12/8/2014	Mowed grass (1.1 miles)			
-----------	-------------------------	--	--	--

CR 238 VALLEY WAY DR

Date	Work Done	R&B Material Used	Amount Used	Expense
------	-----------	-------------------	-------------	---------

12/10/2014	Mowed grass (2.6 miles)			
------------	-------------------------	--	--	--

Daily Work History & Materials Used

Period: 12/1/2014 - 12/31/2014

(By Location)

All Assignments

Work: All categories and types

Caldwell County

Work done in Area: Precinct 3

CR 239 CHURCH ST

Date	Work Done	R&B Material Used	Amount Used	Expense
12/10/2014	Mowed grass (0.8 miles)			

CR 240 QUAIL RUN RD.

Date	Work Done	R&B Material Used	Amount Used	Expense
12/12/2014	Mowed grass (0.8 miles)			
12/16/2014	Installed "County Maint. Begins" sign	#30901 - 10' Green U-Channel Post	1 each	\$19.59
		County maint. Begins (24x18)	1 each	\$23.50
		County Maint. Ends (24x18)	1 each	\$23.50
			Location Total =	\$66.59

CR 241 RAILROAD ST

Date	Work Done	R&B Material Used	Amount Used	Expense
12/9/2014	Mowed grass (1.4 miles)			

CR 244 SPOKE HOLLOW RD

Date	Work Done	R&B Material Used	Amount Used	Expense
12/18/2014	Mowed grass (1.2 miles)			
12/22/2014	Bladed surface (1.2 miles)			

CR 245 SEALS CREEK RD

Date	Work Done	R&B Material Used	Amount Used	Expense
12/22/2014	Bladed surface (1 mile)			

CR 258 CROSSROADS DR

Date	Work Done	R&B Material Used	Amount Used	Expense
12/15/2014	Mowed grass (0.6 miles)			
12/22/2014	Patched road surface (0.6 miles) (Type D - 1.5 T)	Type D Cold Mix	1.5 ton(s)	\$97.50
			Location Total =	\$97.50

Daily Work History & Materials Used

Period: 12/1/2014 - 12/31/2014

(By Location)

All Assignments

Work: All categories and types

Caldwell County

Work done in Area: Precinct 3

CR 285 SECOND ST

Date	Work Done	R&B Material Used	Amount Used	Expense
12/9/2014	Mowed grass (0.2 miles)			

CR 286 MAIN ST

Date	Work Done	R&B Material Used	Amount Used	Expense
12/9/2014	Mowed grass (0.2 miles)			

CR 287 THIRD ST

Date	Work Done	R&B Material Used	Amount Used	Expense
12/9/2014	Mowed grass (0.2 miles)			

CR 288 FOURTH ST

Date	Work Done	R&B Material Used	Amount Used	Expense
12/9/2014	Mowed grass (0.2 miles)			

CR 289 MESQUITE DR

Date	Work Done	R&B Material Used	Amount Used	Expense
12/9/2014	Mowed grass (0.2 miles)			

CR 290 LIVE OAK DR

Date	Work Done	R&B Material Used	Amount Used	Expense
12/9/2014	Mowed grass (0.2 miles)			

Material Total for this Area = \$5,771.37

Daily Work History & Materials Used

Period: 12/1/2014 - 12/31/2014

(By Location)

All Assignments

Work: All categories and types

Caldwell County

Work done in Area: Precinct 4

HIGHLAND RANCH WAY Highland Ranch Sub. - Phase 1

Date	Work Done	R&B Material Used	Amount Used	Expense
12/23/2014	Put up COUNTY road name sign @ Everest Cove	County Road Name Sign	2 each	\$13.90
			Location Total =	\$13.90

TIERRA VERDE RUN Tierra Verde Sub

Date	Work Done	R&B Material Used	Amount Used	Expense
12/19/2014	Installed 6' post w/reflector	#30920 - 6' Green Delineator Post	4 each	\$27.92
		#30920 - 6' Green Delineator Post	0 each	\$0.00
			Location Total =	\$27.92

CR 50 REATA RANCH RD

Date	Work Done	R&B Material Used	Amount Used	Expense
12/5/2014	Mowed grass (0.6 miles)			

CR 86 CRICKET HOLLOW RD

Date	Work Done	R&B Material Used	Amount Used	Expense
12/5/2014	Mowed grass (0.4 miles)			

CR 95 MULESHOE RD

Date	Work Done	R&B Material Used	Amount Used	Expense
12/16/2014	Mowed grass (0.4 miles)			

CR 96A COYOTE RUN

Date	Work Done	R&B Material Used	Amount Used	Expense
12/10/2014	Mowed grass (0.5 miles)			

CR 96 SAGE HOLLOW RD

Date	Work Done	R&B Material Used	Amount Used	Expense
12/2/2014	Bladed surface (0.5 miles)			
12/16/2014	Mowed grass (0.5 miles)			

Daily Work History & Materials Used

Period: 12/1/2014 - 12/31/2014

(By Location)

All Assignments

Work: All categories and types

Caldwell County

Work done in Area: Precinct 4

CR 96 SAGE HOLLOW RD

Date	Work Done	R&B Material Used	Amount Used	Expense
------	-----------	-------------------	-------------	---------

CR 97 GRANDPA RD

Date	Work Done	R&B Material Used	Amount Used	Expense
------	-----------	-------------------	-------------	---------

12/3/2014	Bladed surface (0.4 miles)			
-----------	----------------------------	--	--	--

12/8/2014	Mowed grass (0.4 miles)			
-----------	-------------------------	--	--	--

CR 98 SPOTTED HORSE TR

Date	Work Done	R&B Material Used	Amount Used	Expense
------	-----------	-------------------	-------------	---------

12/8/2014	Mowed grass (1 mile)			
-----------	----------------------	--	--	--

CR 99 QUAIL RIDGE DR

Date	Work Done	R&B Material Used	Amount Used	Expense
------	-----------	-------------------	-------------	---------

12/9/2014	Mowed grass (0.3 miles)			
-----------	-------------------------	--	--	--

CR 160 OLD COLONY LINE RD (FM 1854 To E.FM.20)

Date	Work Done	R&B Material Used	Amount Used	Expense
------	-----------	-------------------	-------------	---------

12/2/2014	Mowed grass (2 miles)			
-----------	-----------------------	--	--	--

CR 164 TUMBLEWEED TR

Date	Work Done	R&B Material Used	Amount Used	Expense
------	-----------	-------------------	-------------	---------

12/2/2014	Mowed grass (3.1 miles)			
-----------	-------------------------	--	--	--

CR 165 SANDHOLLER RD

Date	Work Done	R&B Material Used	Amount Used	Expense
------	-----------	-------------------	-------------	---------

12/1/2014	Mowed grass (2.5 miles) (CR 294 to CR 168)			
-----------	--	--	--	--

12/22/2014	Bladed surface; added base (0.6 miles) (3/4" Base - 96 T)	3/4" base to dust	96 ton(s)	\$1,389.12
------------	---	-------------------	-----------	------------

Daily Work History & Materials Used

Period: 12/1/2014 - 12/31/2014

(By Location)

All Assignments

Work: All categories and types

Caldwell County

Work done in Area: Precinct 4

CR 165 SANDHOLLER RD

Date	Work Done	R&B Material Used	Amount Used	Expense
			Location Total =	\$1,389.12

CR 166 TRACK RD

Date	Work Done	R&B Material Used	Amount Used	Expense
12/11/2014	Patched road surface (Type D - 2 T)	Type D Cold Mix	2 ton(s)	\$130.00
			Location Total =	\$130.00

CR 170 CROOKED RD

Date	Work Done	R&B Material Used	Amount Used	Expense
12/3/2014	Hauled off brush (2.6 miles)			
	Bladed surface (2.6 miles)			
12/17/2014	Mowed grass (2.6 miles)			

CR 171 SEMINOLE TR

Date	Work Done	R&B Material Used	Amount Used	Expense
12/3/2014	Bladed surface (1.5 miles)			
12/17/2014	Mowed grass (1.8 miles)			

CR 172A COUNTY LINE RD

Date	Work Done	R&B Material Used	Amount Used	Expense
12/17/2014	Mowed grass (1.5 miles)			
	Patched road surface (1 mile) (Type D - 5 T)	Type D Cold Mix	5 ton(s)	\$325.00
12/18/2014	Patched road surface (0.5 miles) (Type D - 1 T)	Type D Cold Mix	1 ton(s)	\$65.00
			Location Total =	\$390.00

CR 172 COUNTY LINE RD

Date	Work Done	R&B Material Used	Amount Used	Expense
12/17/2014	Mowed grass (1.6 miles)			
12/18/2014	Patched road surface (1.6 miles) (Type D - 4 T)	Type D Cold Mix	4 ton(s)	\$260.00
	Hauled off brush			

Daily Work History & Materials Used

Period: 12/1/2014 - 12/31/2014

(By Location)

All Assignments

Work: All categories and types

Caldwell County

Work done in Area: Precinct 4

CR 172 COUNTY LINE RD

Date	Work Done	R&B Material Used	Amount Used	Expense
12/19/2014	Installed 6' post w/reflector	#30147 - Yellow Delineator - 4x4	1 each	\$1.70
		#30920 - 6' Green Delineator Post	1 each	\$6.98
			Location Total =	\$268.68

CR 174 LYTTON LN

Date	Work Done	R&B Material Used	Amount Used	Expense
12/1/2014	Bladed surface (1 mile)			
12/2/2014	Bladed surface (3.3 miles)			
12/16/2014	Mowed grass (3.9 miles)			

CR 175 TOMAHAWK TR

Date	Work Done	R&B Material Used	Amount Used	Expense
12/1/2014	Bladed surface (2 miles)			
12/16/2014	Mowed grass (2 miles)			

CR 176 OLD LOCKHART RD (CR 177 to Hwy. 21)

Date	Work Done	R&B Material Used	Amount Used	Expense
12/9/2014	Mowed grass (1.5 miles)			

CR 176 OLD LOCKHART RD (CR 179 to CR 177)

Date	Work Done	R&B Material Used	Amount Used	Expense
12/9/2014	Mowed grass (0.3 miles)			

CR 177 WILLIAMSON RD (FM 1854 to CR 176)

Date	Work Done	R&B Material Used	Amount Used	Expense
12/3/2014	Bladed surface (2.6 miles)			
12/10/2014	Mowed grass (2.6 miles)			

Daily Work History & Materials Used

Period: 12/1/2014 - 12/31/2014

(By Location)

All Assignments

Work: All categories and types

Caldwell County

Work done in Area: Precinct 4

CR 177 WILLIAMSON RD (CR 176 to Hwy. 183)

Date	Work Done	R&B Material Used	Amount Used	Expense
12/10/2014	Mowed grass (0.2 miles)			

CR 178 HOMANN RD

Date	Work Done	R&B Material Used	Amount Used	Expense
12/3/2014	Bladed surface (2 miles)			
12/8/2014	Mowed grass (2 miles)			

CR 179 BARTH RD (1854 to FM 672)

Date	Work Done	R&B Material Used	Amount Used	Expense
12/3/2014	Hauled off brush (1.5 miles)			
12/5/2014	Mowed grass (1.4 miles)			

CR 179 BARTH RD (FM 672 to FM 1185)

Date	Work Done	R&B Material Used	Amount Used	Expense
12/1/2014	Bladed surface; added base (2 miles) (3/4" base - 120 T)	3/4" base to dust	120 ton(s)	\$1,736.40
12/5/2014	Mowed grass (3.8 miles)			
12/8/2014	Blade cold mix on road surface (0.2 miles) (Type D - 120 T)	Type D Cold Mix	120 ton(s)	\$7,800.00
12/10/2014	Bladed surface; added base (Type D - 288 T)	Type D Cold Mix	288 ton(s)	\$18,720.00
12/11/2014	Repaired driveway entrance			
12/12/2014	Blade cold mix on road surface (0.7 miles) (Type D - 288 T)	Type D Cold Mix	288 ton(s)	\$18,720.00
12/16/2014	Blade cold mix on road surface (0.1 miles) (Type D - 168 T; 3/4" Base - 48 T)	3/4" base to dust Type D Cold Mix	48 ton(s) 168 ton(s)	\$694.56 \$10,920.00
12/17/2014	Bladed surface; added base (3/4" Base - 168 T)	3/4" base to dust	168 ton(s)	\$2,430.96
			Location Total =	\$61,021.92

Daily Work History & Materials Used

Period: 12/1/2014 - 12/31/2014

(By Location)

All Assignments

Work: All categories and types

Caldwell County

Work done in Area: Precinct 4

CR 179 HOMANNVILLE TR (FM 1185 to Hwy. 183)

Date	Work Done	R&B Material Used	Amount Used	Expense
12/2/2014	Bladed surface (3.8 miles)			
12/8/2014	Mowed grass (2 miles) (FM 1185 to CR 178)			
12/9/2014	Mowed grass (1.5 miles)			

CR 180 LIBERTY LN

Date	Work Done	R&B Material Used	Amount Used	Expense
12/5/2014	Mowed grass (0.5 miles)			
12/29/2014	Bladed surface; added base (0.1 miles) (3/4" Base - 120 T.)	3/4" base to dust	120 ton(s)	\$1,736.40
			Location Total =	\$1,736.40

CR 181 LIVELY STONE RD

Date	Work Done	R&B Material Used	Amount Used	Expense
12/3/2014	Mowed grass (0.7 miles)			

CR 182 DRY CREEK RD (FM 672 to Gravel)

Date	Work Done	R&B Material Used	Amount Used	Expense
12/4/2014	Mowed grass (0.8 miles)			

CR 182 DRY CREEK RD (Gravel to CR 183)

Date	Work Done	R&B Material Used	Amount Used	Expense
12/4/2014	Mowed grass (3.9 miles)			
12/16/2014	Replaced 6' post	#30920 - 6' Green Delineator Post	3 each	\$20.94
			Location Total =	\$20.94

CR 183 OLD LYTTON SPRINGS RD

Date	Work Done	R&B Material Used	Amount Used	Expense
12/4/2014	Mowed grass (2.1 miles)			

Daily Work History & Materials Used

Period: 12/1/2014 - 12/31/2014

(By Location)

All Assignments

Work: All categories and types

Caldwell County

Work done in Area: Precinct 4

CR 184 PEGASUS RD

Date	Work Done	R&B Material Used	Amount Used	Expense
12/4/2014	Mowed grass (0.6 miles)			

CR 185 WITTER RD (From Stoney Daile to FM 672)

Date	Work Done	R&B Material Used	Amount Used	Expense
12/3/2014	Mowed grass (2.1 miles)			

CR 186 OLD KELLEY RD (From C/L to bridge)

Date	Work Done	R&B Material Used	Amount Used	Expense
12/30/2014	Bladed surface (0.8 miles)			

CR 189 THOMPSON RD

Date	Work Done	R&B Material Used	Amount Used	Expense
12/2/2014	Mowed grass (1.2 miles)			

CR 255 GREEN ACRE DR

Date	Work Done	R&B Material Used	Amount Used	Expense
12/2/2014	Mowed grass (0.6 miles)			

CR 256 CAT BRANCH RD

Date	Work Done	R&B Material Used	Amount Used	Expense
12/22/2014	Bladed surface; added base (0.3 miles) (3/4" base - 48 T)	3/4" base to dust	48 ton(s)	\$694.56

Location Total = \$694.56

CR 291 MEMORIAL DR

Date	Work Done	R&B Material Used	Amount Used	Expense
12/16/2014	Mowed grass (0.3 miles)			

Daily Work History & Materials Used

Period: 12/1/2014 - 12/31/2014

(By Location)

All Assignments

Work: All categories and types

Caldwell County

Work done in Area: Precinct 4

CR 291 MEMORIAL DR

Date	Work Done	R&B Material Used	Amount Used	Expense
------	-----------	-------------------	-------------	---------

CR 292 HANGING OAK RD (FM 1854 to dead end)

Date	Work Done	R&B Material Used	Amount Used	Expense
------	-----------	-------------------	-------------	---------

12/16/2014 Mowed grass (0.4 miles)

CR 293 CLENDENNEN LN

Date	Work Done	R&B Material Used	Amount Used	Expense
------	-----------	-------------------	-------------	---------

12/16/2014 Mowed grass (0.2 miles)

CR 294 DALE LN

Date	Work Done	R&B Material Used	Amount Used	Expense
------	-----------	-------------------	-------------	---------

12/1/2014 Mowed grass (1.8 miles) (From FM 1854)

CR 295 EASY ST

Date	Work Done	R&B Material Used	Amount Used	Expense
------	-----------	-------------------	-------------	---------

12/2/2014 Mowed grass (0.2 miles)

CR 296 PACKARD DR

Date	Work Done	R&B Material Used	Amount Used	Expense
------	-----------	-------------------	-------------	---------

12/2/2014 Mowed grass (0.1 miles)

CR 297 MAIN ST

Date	Work Done	R&B Material Used	Amount Used	Expense
------	-----------	-------------------	-------------	---------

12/1/2014 Mowed grass (0.1 miles)

Daily Work History & Materials Used

Period: 12/1/2014 - 12/31/2014

(By Location)

All Assignments

Work: All categories and types

Caldwell County

Work done in Area: Precinct 4

CR 298 OAKWOOD DR

Date	Work Done	R&B Material Used	Amount Used	Expense
12/1/2014	Mowed grass (0.2 miles)			

CR 303 HIDDEN PATH RD

Date	Work Done	R&B Material Used	Amount Used	Expense
12/1/2014	Mowed grass (0.3 miles)			

CR 312 SUNRISE ST

Date	Work Done	R&B Material Used	Amount Used	Expense
12/16/2014	Mowed grass (0.3 miles)			

CR 400 OAK TRAIL DR

Date	Work Done	R&B Material Used	Amount Used	Expense
12/4/2014	Mowed grass (0.8 miles)			

CR 401 OAK COVE

Date	Work Done	R&B Material Used	Amount Used	Expense
12/4/2014	Mowed grass (0.2 miles)			

CR 402 ALAMO DR

Date	Work Done	R&B Material Used	Amount Used	Expense
12/4/2014	Mowed grass (0.4 miles)			

Material Total for this Area = \$65,693.44

Daily Work History & Materials Used

Period: 12/1/2014 - 12/31/2014

(By Location)

All Assignments

Work: All categories and types

Caldwell County

Work done in Area: Pcts 1 & 2
--

CR 114 MINERAL SPRINGS RD (Hwy. 183 to FM 671)

Date	Work Done	R&B Material Used	Amount Used	Expense
12/2/2014	Bladed surface (1.4 miles)			

CR 198 FOX LN

Date	Work Done	R&B Material Used	Amount Used	Expense
12/1/2014	Bladed surface (0.2 miles)			
12/11/2014	Hauled off brush			
	Installed 6' post w/reflector	#30147 - Yellow Delineator - 4x4	2 each	\$3.40
		#30920 - 6' Green Delineator Post	2 each	\$13.96
12/19/2014	Re-installed "curve" signs	#30901 - 10' Green U-Channel Post	1 each	\$19.59
		#W1-2L - Left Curve Arrow - (24x24)	2 each	\$62.00
		#W1-2R - Right Curve Arrow - (24x24)	1 each	\$31.00
			Location Total =	\$129.95

Material Total for this Area = \$129.95

Daily Work History & Materials Used

Period: 12/1/2014 - 12/31/2014

(By Location)

All Assignments

Work: All categories and types

Caldwell County

Work done in Area: Pcts 1 & 3

CR 104 CISTERN RD

Date	Work Done	R&B Material Used	Amount Used	Expense
12/9/2014	Mowed grass (0.2 miles)			

CR 109 BLACK ANKLE RD (From W. FM 20 to CR 107)

Date	Work Done	R&B Material Used	Amount Used	Expense
12/1/2014	Patched road surface (1 mile) (Type D - 3 T)	Type D Cold Mix	3 ton(s)	\$195.00
12/3/2014	Trimmed brush or trees (1 mile)			
12/4/2014	Trimmed brush or trees (0.7 miles)			
12/5/2014	Trimmed brush or trees (0.4 miles)			
			Location Total =	\$195.00

CR 109B MARTINDALE LAKE RD

Date	Work Done	R&B Material Used	Amount Used	Expense
12/9/2014	Mowed grass (0.4 miles)			

CR 109A TOWER RD

Date	Work Done	R&B Material Used	Amount Used	Expense
12/16/2014	Mowed grass (0.9 miles)			

CR 221 ROLLING RIDGE RD (Hwy. 183 to CR 233)

Date	Work Done	R&B Material Used	Amount Used	Expense
12/2/2014	Mowed grass (1.7 miles)			

CR 230 JOLLEY RD (CR 104 to FM 2720)

Date	Work Done	R&B Material Used	Amount Used	Expense
12/8/2014	Mowed grass (2.8 miles)			

Daily Work History & Materials Used

Period: 12/1/2014 - 12/31/2014

(By Location)

All Assignments

Work: All categories and types

Caldwell County

Work done in Area: Pcts 1 & 3

CR 232 BOBWHITE RD

Date	Work Done	R&B Material Used	Amount Used	Expense
12/1/2014	Mowed grass (1.5 miles)			
12/29/2014	Bladed surface; added base (0.1 miles) (3/4" Base - 168 T.)	3/4" base to dust	168 ton(s)	\$2,430.96
12/30/2014	Bladed surface; added base (0.1 miles) (3/4" Base - 192 T.)	3/4" base to dust	192 ton(s)	\$2,778.24
			Location Total =	\$5,209.20

CR 233 POLONIA RD

Date	Work Done	R&B Material Used	Amount Used	Expense
12/1/2014	Mowed grass (1.9 miles)			
12/3/2014	Mowed grass (1.9 miles)			

Material Total for this Area = \$5,404.20

Daily Work History & Materials Used

Period: 12/1/2014 - 12/31/2014

(By Location)

All Assignments

Work: All categories and types

Caldwell County

Work done in Area: Pcts 1 & 4
--

CR 80 BRANDING IRON TR

Date	Work Done	R&B Material Used	Amount Used	Expense
12/3/2014	Mowed grass (0.2 miles)			

CR 185 WITTER RD (From FM 186 to Stoney Daile)

Date	Work Done	R&B Material Used	Amount Used	Expense
12/3/2014	Mowed grass (0.6 miles)			

CR 186 OLD KELLEY RD (Bridge to CR 185)

Date	Work Done	R&B Material Used	Amount Used	Expense
12/3/2014	Mowed grass (1.4 miles)			

Daily Work History & Materials Used

Period: 12/1/2014 - 12/31/2014

(By Location)

All Assignments

Work: All categories and types

Caldwell County

Work done in Area: Pets 2 & 3

CR 112 CALLIHAN RD (From CR 115 to San Marcos Hwy.)

Date	Work Done	R&B Material Used	Amount Used	Expense
12/1/2014	Patched road surface (2 miles) (Type D - 2 T)	Type D Cold Mix	2 ton(s)	\$130.00
12/8/2014	Trimmed brush or trees (0.3 miles)			
12/9/2014	Trimmed brush or trees (1.2 miles)			
12/12/2014	Trimmed brush or trees (1 mile)			
12/15/2014	Trimmed brush or trees (1.3 miles)			
12/18/2014	Trimmed brush or trees (1.2 miles)			
			Location Total =	\$130.00
			Material Total for this Area =	\$130.00

Daily Work History & Materials Used

Period: 12/1/2014 - 12/31/2014

(By Location)

All Assignments

Work: All categories and types

Caldwell County

Work done in Area: County

(location not on list)

Date	Work Done	R&B Material Used	Amount Used	Expense
12/9/2014	Mowed grass (1.7 miles)			
12/12/2014	Mowed grass (1.5 miles)			
	Mowed grass (0.1 miles)			
12/15/2014	Mowed grass (1.8 miles)			

Material Total for all Areas = \$97,416.09

2015 Budget Summary

Year-to-Date Report: 10/1/2014 - 1/13/2015

All Assignments

Caldwell County

Account Code	Account Name	Budgeted Amount	Recorded Invoices	Estimated Residual
002-1101-2140	Uniforms	\$32,000.00	\$9,119.17	\$22,880.83
002-1101-3116	Culvert Pipe	\$15,000.00	\$2,922.85	\$12,077.15
002-1101-3130	Operating Supplies	\$35,000.00	\$9,145.09	\$25,854.91
002-1101-3143	Flex Base Materials	\$200,000.00	\$91,887.06	\$108,112.94
002-1101-3153	Aggregate/Gravel	\$250,000.00	\$217,545.39	\$32,454.61
002-1101-3163	Fuel	\$240,000.00	\$43,806.33	\$196,193.67
002-1101-3170	Lubricants	\$15,000.00	\$0.00	\$15,000.00
002-1101-3181	Signs	\$20,000.00	\$6,625.10	\$13,374.90
002-1101-3190	Tires	\$30,000.00	\$13,628.63	\$16,371.37
002-1101-4610	Rentals	\$4,500.00	\$285.60	\$4,214.40
002-1101-4620	Dust Control	\$100,000.00	\$12,211.83	\$87,788.17
002-1101-4630	Seal Coating	\$210,000.00	\$0.00	\$210,000.00
002-1102-3136	Supplies/Small Tools	\$70,000.00	\$15,645.56	\$54,354.44
002-1102-4510	Repairs & Maintenance	\$30,000.00	\$8,569.25	\$21,430.75
002-1103-2140	Uniforms (Fleet Maint)	\$3,500.00	\$769.75	\$2,730.25
002-1103-3110	Office Supplies (Fleet Maint)	\$500.00	\$0.00	\$500.00
002-1103-3135	Operating Supplies (Fleet Maint)	\$60,000.00	\$7,598.44	\$52,401.56
002-1103-3165	Oil & Lubricants (Fleet Maint)	\$7,850.00	\$1,640.00	\$6,210.00
002-1103-3190	Tires (Fleet Maint)	\$15,000.00	\$3,701.62	\$11,298.38
002-1103-4529	Contract Labor (Fleet Maint)	\$15,000.00	\$69.95	\$14,930.05

Column Totals = \$1,353,350.00 \$445,171.62 \$908,178.38

Equipment Maintenance Details

Equipment: All types
 Maintenance: All categories
 Personnel: All personnel

Caldwell County
 All assignments
 12/1/2014 - 12/31/2014

District Attorney's Office

DA2 Pick-up 2002 Ford F150 (District Attorney)

Date	Maintenance Category	When	Personnel
12/11/2014	Routine service	246352 miles	Darius Musgrave
	Engine	AF1615 (1) air filter, PH820 (1) oil filter, 15W40 (6.5) oil	

Heavy equipment

G-10 Graders - 8332 1997 Gallion 830 (SN#V03623)

Date	Maintenance Category	When	Personnel
12/16/2014	Repair work	10749 hours	Donnie Barker
	Miscellaneous	91468 (1) cyl rebuild - Hydraulic House, GB41017 (2) cutting blades - stock, 060312-0808 (1) hyd fitting - Oreilly	
12/11/2014	Repair work	10749 hours	Donnie Barker
	Electrical	52152 (1) tail light - stock	
12/2/2014	Routine service	10720 hours	Mike Cheatham
	Electrical	52152 (1) light - stock	
	Miscellaneous	GB41017 (2) cutting blades - stock	

G-15 Graders - 8332 2004 Cat 120-H

Date	Maintenance Category	When	Personnel
12/16/2014	Repair work	7730 hours	Richard Martinez
	Miscellaneous	2260 295 (1) lock assy for right door; 2260342 (1) lock latch	
12/11/2014	Routine service	7730 hours	Donnie Barker
	Engine	15-40 (5 gal.) oil - stock	
	Engine	wix24314 (2) cabin filter, wix33640 (1) fuel filter, wix46476 (1) air filter, wix46477 (1) air filter, wix46689 (1) cabin filter, wix51792 (1) oil filter, wix57720 (1) trans filter, misff186SP (1) hyd filter, mispt8461 (1) fuel filter -all Parts Plus	
12/4/2014	Routine service	7712 hours	Donnie Barker
	Miscellaneous	GB41017 (2) cutting blades - stock	

G-16 Graders - 8332 2004 Cat 120-H

Date	Maintenance Category	When	Personnel
12/15/2014	Routine service	7862 hours	Donnie Barker
	Miscellaneous	GB41017 (2) blades - stock	

Equipment Maintenance Details

Equipment: All types
 Maintenance: All categories
 Personnel: All personnel

Caldwell County
 All assignments
 12/1/2014 - 12/31/2014

Heavy equipment

G-17 Graders - 8332 2004 Cat 120-H

Date	Maintenance Category	When	Personnel
12/11/2014	Repair work	6840 hours	Donnie Barker
	Brakes	114-9281 (1) air brake switch, 253-4347 (1) air valve, 185-0008 (1) solenoid valve - All Holt Cat	
12/5/2014	Routine service	6835 hours	Richard Martinez
	Engine	15-40 (7) gal oil - stock, 51792 (1) oil filter, 533640 (1) fuel, 57197 (1) hyd, 57720 (1) hyd, 524314 (2) cab air, FF1186SP (1) fuel filter, 46477 (1) inner air, 46476 (1) outer air	
	Miscellaneous	GB41017 (2) blades - stock	

G-18 Graders - 8332 2004 Cat 120-H

Date	Maintenance Category	When	Personnel
12/18/2014	Routine service	8182 hours	Donnie Barker
	Engine	533640 (1) fuel filter, FF1186SP (1) fuel filter, 46476 (1) air filter, 46477 (1) air, 51792 (1) oil filter, 57720 (1) trans filter, 57197 (1) hyd filter, 46689 (1) cabin air, 524314 (2) cabin air, 15-40 (5 gal) oil	
	Miscellaneous	NB-18 (1) wiper blades	
12/2/2014	Routine service	8541 hours	Richard Martinez
	Miscellaneous	(2) blades	

G-9 Graders - 8332 1997 Gallion 830 (SN#V03622)

Date	Maintenance Category	When	Personnel
12/17/2014	Routine service	11304 hours	Richard Martinez
	Engine	51607 (1) oil filter, 42674 (1) outer air filter, 42675 (1) inner air filter, 51495 (1) hyd filter, 33357 (1) fuel filter, 33358 (1) fuel filter, 15-40 (4 gal) oil, (1) gal ATF	
	Miscellaneous	40212 (2) light - Napa, HR2C06 (1) hose, HY06-06FJ (2) JIC 37 Female Swivel	

R-1 Compactor, Vibratory, Drum - 8222 Roller, Steel Wheel 2000 Dynapac

Date	Maintenance Category	When	Personnel
12/30/2014	Routine service	2468 hours	Donnie Barker
	Engine	33253 (1) inline fuel - Parts Plus, 4700373688 - coolant hose - Closner	
	Engine	33357 (1) fuel filter, 33358 (1) fuel seperator, 46761 (1) air filter, 46766 (1) air, 51495 (2) hyd filter, 51602 (1) oil filter - all Parts Plus; 15-40 oil (5 gal.) stock	

Equipment Maintenance Details

Equipment: All types
 Maintenance: All categories
 Personnel: All personnel

Caldwell County
 All assignments
 12/1/2014 - 12/31/2014

Heavy equipment

R-2 Compactor, Vibratory, Drum - 8222 Roller, Steel Wheel 2008 Volvo

Date	Maintenance Category	When	Personnel
12/8/2014	Repair work	660 hours	Donnie Barker
	Miscellaneous	GRO16244 (1) mirror - Parts Plus	

Heavy vehicles

D-1 Truck, Dump - 8720 2009 Ford (8 yd)

Date	Maintenance Category	When	Personnel
12/1/2014	Repair work	74889 miles	Richard Martinez
	Miscellaneous	RB18530 (1) air valve	

D-16 Truck, Dump - 8720 1998 Ford (8 yd)

Date	Maintenance Category	When	Personnel
12/17/2014	Inspection sticker	141833 miles	Mike Cheatham
	Brakes	1BBHRB103009 (1) brake valve	
	Miscellaneous	NP69SW6-4 (6) nylon push on male 90 swivel - Fleet Pride, (1) mud flap	

D-44 Truck, Tractor - 8792 2008 Freightliner

Date	Maintenance Category	When	Personnel
12/22/2014	Repair work	188095 miles	Mike Cheatham
	Steering	110110800 (1) spring brake control valve, 114AV800333 (1) in line quick release valve - both Fleet Pride	
12/16/2014	Repair work	187929 miles	Donnie Barker
	Wheels	R268 (2) bridgestone 11.R.22.5 - stock, R805157 (1) dash valve air brake, 11R22.5 (2) recap tires - stock	

D-45 Truck, Tractor - 8792 2008 Freightliner

Date	Maintenance Category	When	Personnel
12/4/2014	Repair work	185601 miles	Mike Cheatham
	Wheels	(2) bridgestone R268 - stock	

Equipment Maintenance Details

Equipment: All types
 Maintenance: All categories
 Personnel: All personnel

Caldwell County
 All assignments
 12/1/2014 - 12/31/2014

Light vehicles

M1 Truck, Pickup - 8802 2013 Ford F250 Supercab			
Date	Maintenance Category	When	Personnel
12/3/2014	Routine service	35301 miles	Richard Martinez
	Engine	1372 (1) oil filter, 5-20 (7.5) oil	
	Inspection	(1) G29766941 - state inspection	
M2 Truck, Pickup - 8802 2013 Ford F250 Supercab			
Date	Maintenance Category	When	Personnel
12/12/2014	Inspection sticker	70239 miles	Richard Martinez
	Inspection	state inspection - G29766942	
12/2/2014	Routine service	69348 miles	Richard Martinez
	Engine	9883 (1) air filter, 1372 (1) oil filter, 5-20 (7.5) oil	
M3 Truck, Pickup - 8802 2013 Ford F250 Supercab			
Date	Maintenance Category	When	Personnel
12/10/2014	Inspection sticker	51956 miles	Richard Martinez
	Inspection	State Inspection - G29766943	
MAINT-2 Truck, Pickup - 8805 2000 Chev			
Date	Maintenance Category	When	Personnel
12/5/2014	Repair work	251624 miles	Donnie Barker
	Brakes	MKD-194 (1) rear brake pads - Parts Plus	
Unit -1 Truck, Pickup - 8802 2009 Chevy 2500 Silverado			
Date	Maintenance Category	When	Personnel
12/12/2014	Routine service	97739 miles	Mike Cheatham
	Engine	15-40 (7qts.) oil, 7060 (1) oil filter - stock	
	Inspection	G29766944 - state inspection	
Unit -2 Truck, Pickup - 8802 2009 Chev 2500 Silverado			
Date	Maintenance Category	When	Personnel
12/22/2014	Inspection sticker	153719 miles	Donnie Barker
	Inspection	G29766946 - state inspection	

Equipment Maintenance Details

Equipment: All types
 Maintenance: All categories
 Personnel: All personnel

Caldwell County
 All assignments
 12/1/2014 - 12/31/2014

Light vehicles

Unit -3 Truck, Pickup - 8802 2009 Chevy 2500 Silverado

Date	Maintenance Category	When	Personnel
12/9/2014	Routine service	135142 miles	Richard Martinez
	Engine	2487 (1) air filter, 7060 (1) oil filter, 15-40 (7 qt.) oil	

Tractors & attachments

FT-10 Tractor 1998 New Holland 5610

Date	Maintenance Category	When	Personnel
12/11/2014	Repair work		Donnie Barker
	Electrical	6572 (1) super start battery	
12/4/2014	Repair work		Donnie Barker
	Miscellaneous	00750616 (2) hub seal, Hub-0904 (1) jam nut, 913622 (1) spindle washer, LM29710 TIM (1) bearing cup, LM29749 (1) bearing cone, 00756489 (1) bearing, wheel hub	

FT-11 Tractor 1998 New Holland 5610

Date	Maintenance Category	When	Personnel
12/9/2014	Repair work		Donnie Barker
	Miscellaneous	75C1000HC55 (2) - Hansons, 75CNFH (2) nuts - Hansons, W54204 (1) grease gun - stock	
12/2/2014	Repair work		Donnie Barker
	Engine	99302886600 (4) head bolts, 390029605538 (1) spindle assy, 39000003901 (4) washer, 39002961038 (1) gasket - all Ewald	
	Miscellaneous	P02962635 (3) blades - stock	

FT-14 Tractor 2007 Zetor 6441.0SR

Date	Maintenance Category	When	Personnel
12/8/2014	Repair work	2394 hours	Donnie Barker
	Wheels	00025200 (1) tire/wheel - Hanson	

FT-16 Mahindra 2012 8560 M Power 4WD

Date	Maintenance Category	When	Personnel
12/10/2014	Repair work	400 hours	Mike Cheatham
	Wheels	CM5634 (1) 18-4-30/1- cropmax rear tires, 323780 (1) 16.9 184R30 Tube - both Hanson	

Equipment Maintenance Details

Equipment: All types
 Maintenance: All categories
 Personnel: All personnel

Caldwell County
 All assignments
 12/1/2014 - 12/31/2014

Emergency Mgmt.

EM2 Pick-up truck 2012 Chev			
Date	Maintenance Category	When	Personnel
12/22/2014	Repair work	31596 miles	John Franklin
	Electrical	INV07JD2820 (1) assorted wire connect, INV07JD3510 (1) assorted wire connect, INV07JD2671 (1) assorted wire connect	
12/10/2014	Repair work	31106 miles	John Franklin
	Engine	AF1915 (1) air filter, PH48 (1) oil filter, 15W40 (6) oil	
	Miscellaneous	Latitude (2) Rain X wiper blades	

Juvenile Probation Dept.

JP4 Car 2006 Ford Crown Victoria (Juvenile Probation)			
Date	Maintenance Category	When	Personnel
12/3/2014	Inspection sticker	94204 miles	Darius Musgrave
	Inspection	(1) state inspection - G36905728	
12/2/2014	Routine service	94194 miles	John Franklin
	Engine	PF1032A (1) air filter, PH820 (1) oil filter, 15W40 (6.5) oil	

Sheriff's Dept.

10 Car 2010 Ford 4 door			
Date	Maintenance Category	When	Personnel
12/30/2014	Repair work	127967 miles	John Franklin
	Wheels	P235/55R17 (2) Eagle RSA Goodyear, TR413 (2) valve stem, (4) wheel weights	
12/1/2014	Routine service	124947 miles	John Franklin
	Engine	AF1032A (1) air filter, PH2835 (1) oil filter, 15W40 (6.5) oil	

102 Car 1999 Ford Crown Victoria 4 door			
Date	Maintenance Category	When	Personnel
12/5/2014	Repair work	159853 miles	Darius Musgrave
	Miscellaneous	741-664 (1) window regulator	
12/3/2014	Inspection sticker	159770 miles	John Franklin
	Inspection	(1) state inspection - G36905726	
	Miscellaneous	(1) sea foam	

Equipment Maintenance Details

Equipment: All types
 Maintenance: All categories
 Personnel: All personnel

Caldwell County
 All assignments
 12/1/2014 - 12/31/2014

Sheriff's Dept.

208 Car 2002 Ford Crown Victoria (Jail)

Date	Maintenance Category	When	Personnel
12/3/2014	Inspection sticker	219335 miles	John Franklin
	Engine	G6593 (1) fuel filter, E23825 (1) fuel pump	
	Inspection	(1) state inspection - G36905727	
	Wheels	P225/60R16 (1) eagle RSA (Goodyear), TR413 (1) valve stem, (2) wheel weights	

212 Pick-up 2002 Ford F250 (Jail)

Date	Maintenance Category	When	Personnel
12/4/2014	Routine service	175476 miles	John Franklin
	Engine	AF1516 (1) air filter, PH820 (1) oil filter, 15W40 (6.5) oil	

3 Car, Ford Crown Victoria

Date	Maintenance Category	When	Personnel
12/18/2014	Routine service	86132 miles	John Franklin
	Engine	46893 (1) air filter, 57502 (1) oil filter, 15W40 (6) oil	

302 SUV 2013 Ford Police Interceptor Utility

Date	Maintenance Category	When	Personnel
12/3/2014	Routine service	49500 miles	John Franklin
	Engine	46935 (1) air filter, 57502 (1) oil filter, 15W40 (6) oil	

403 Interceptor 2014 Ford Utility

Date	Maintenance Category	When	Personnel
12/29/2014	Routine service	21588 miles	John Franklin
	Engine	46935 (1) air filter, 57502 (1) oil filter, 15W40 (6) oil	

404 Interceptor 2014 Ford Utility

Date	Maintenance Category	When	Personnel
12/3/2014	Routine service	27300 miles	John Franklin
	Engine	46935 (1) air filter, 57502 (1) oil filter, 15W40 (6) oil	

405 Utility AWD 2014 Ford Police Interceptor

Date	Maintenance Category	When	Personnel
12/31/2014	Repair work	33114 miles	John Franklin
	Wheels	245/55R18 (2) Eagle RSA Goodyear, (4) wheel weights	

Equipment Maintenance Details

Equipment: All types
 Maintenance: All categories
 Personnel: All personnel

Caldwell County
 All assignments
 12/1/2014 - 12/31/2014

Sheriff's Dept.

405 Utility AWD 2014 Ford Police Interceptor			
Date	Maintenance Category	When	Personnel
12/31/2014	Routine service	33034 miles	John Franklin
	Engine	46935 (1) air filter, 57502 (1) oil filter, 15W40 (6) oil	
12/17/2014	Repair work	31880 miles	John Franklin
	Wheels	(1) flat repair - right front	
602 Pick-up truck 2006 Ford F150			
Date	Maintenance Category	When	Personnel
12/5/2014	Routine service	160948 miles	John Franklin
	Engine	PAF5528 (1) air filter, PH820 (1) oil filter, 15W40 (7) oil	
604 Car 2006 Ford Crown Victoria 4 door			
Date	Maintenance Category	When	Personnel
12/23/2014	Routine service	207730 miles	John Franklin
	Engine	AF1032A (1) air filter, PH820 (1) oil filter, 15W40 (6.5) oil	
	Miscellaneous	31-22 (2) wiper blades	
7 SUV 2010 Ford Escape XLT 4 door (Jail)			
Date	Maintenance Category	When	Personnel
12/4/2014	Routine service	162227 miles	John Franklin
	Engine	46893 (1) air filter, 57502 (1) oil filter, 15W40 (6) oil	
	Inspection	state inspection - G36905729	
8 Car 2010 Ford Sedan			
Date	Maintenance Category	When	Personnel
12/16/2014	Repair work	154598 miles	John Franklin
	Miscellaneous	31-22 (2) wiper blades	
12/8/2014	Routine service	153624 miles	John Franklin
	Engine	AF1032A (1) air filter, PH2835 (1) oil filter, 15W40 (?) oil	
801 Car 2008 Ford Crown Victoria 4 door			
Date	Maintenance Category	When	Personnel
12/1/2014	Repair work	154789 miles	John Franklin
	Engine	SC34DU (1) battery	

Equipment Maintenance Details

Equipment: All types
 Maintenance: All categories
 Personnel: All personnel

Caldwell County
 All assignments
 12/1/2014 - 12/31/2014

Sheriff's Dept.

806 Pick-up 2008 Chevy Silverado

Date	Maintenance Category	When	Personnel
12/10/2014	Routine service	84320 miles	Darius Musgrave
	Engine	AF1519 (1) air filter, PH 48 (1) oil filter, 15W40 (6) oil	

807 Pick-up 2008 Chevy 1500 Silverado

Date	Maintenance Category	When	Personnel
12/18/2014	Routine service	136530 miles	Darius Musgrave
	Engine	AF1519 (1) air filter, PH48 (1) oil filter, 15W40 (6) oil	
	Miscellaneous	C220E (2) wiper blades	

902 Car 2009 Ford Crown Victoria

Date	Maintenance Category	When	Personnel
12/1/2014	Routine service		John Franklin
	Engine	AF1032A (1) air filter, PH2835 (1) oil filter, 15W40 (6.5) oil, SP405 (8) platinum spark plug, 615-175 (1) intake manifold, MP8-61 (2) anti-freeze	

903 Car 2009 Ford Crown Victoria 4 door

Date	Maintenance Category	When	Personnel
12/19/2014	Routine service	192957 miles	John Franklin
	Engine	AF1032A (1) air filter, PH2835 (1) oil filter, 15W40 (6.5) oil	
	Miscellaneous	31-22 (2) wiper blades, 9007 (1) headlight bulb	

TF2 Pick-up truck Ford F150

Date	Maintenance Category	When	Personnel
12/9/2014	Routine service	154056 miles	Darius Musgrave
	Transmission	G6593 (1) fuel filter, B-144 (1) trans filter kit, 41035 (5) Mercon V Trans Fluid	

TF7 SUV 2000 Ford Expedition Zion

Date	Maintenance Category	When	Personnel
12/10/2014	Repair work	154116 miles	Darius Musgrave
	Electrical	9007 (1) headlight bulg	

Equipment Maintenance Details

Equipment: All types
 Maintenance: All categories
 Personnel: All personnel

Caldwell County
 All assignments
 12/1/2014 - 12/31/2014

Sheriff's Dept.

TF7 SUV 2000 Ford Expedition Zion

Date	Maintenance Category	When	Personnel
12/8/2014	Routine service	211193 miles	John Franklin
	Electrical	26912HD (2) battery terminal ends	
	Engine	AF1615 (1) air filter, PH820 (1) oil filter, 15W40 (6.5) oil, 2 lbs. freon	
	Inspection	state inspection - G36905730	
	Miscellaneous	31-16 (1) wiper blades, 40-2030 (1) rear wiper motor, 80050 (1) clear adhesive	

**2015.01.20.07Special Presentations.
None**

2015.01.20.08 Executive Session

pursuant to Sections 551.071 and 551.087 of the Texas Government Code: Consultation with counsel and deliberation regarding economic development negotiations associated with Project Cast. Possible action may follow in open court. **Speaker: Commissioner Munoz.**

2015.01.20.09 Discussion/Action
to authorize the County Judge to
execute a License Agreement with
Camp Gladiator for use of the Justice
Center Grounds. Cost:\$0 **Speaker:**
Commissioner Munoz/ Assistant
District Attorney, Jordan Powell.
Backup:1.

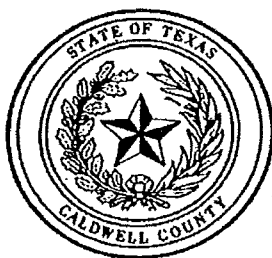

LICENSE AGREEMENT FOR USE OF THE JUSTICE CENTER GROUNDS

This License Agreement for Use of the Justice Center Grounds is made and entered between Caldwell County, Texas ("the County") and Camp Gladiator, Inc. (hereinafter "Licensee") for the Exercise Fitness Boot Camp event.

WHEREAS Licensee wishes to make use of the Caldwell County Justice Center Grounds (hereinafter "the Justice Center Grounds"), located at 1703 S. Colorado Street, Lockhart, Texas 78644 in Caldwell County, Texas.

WHEREAS the County, to promote a sense of community, does, from time to time, allow private and/or public entities temporary license to use the Justice Center Grounds.

NOW, THEREFORE, the County and Licensee agree to the following terms, conditions, rights, and duties:

I.

TERM, HOURS, AND NUMBER

This agreement is effective beginning the ____ day of January, 2015 and ending the 12th day of September, 2015 (hereinafter "the Term") and provides for Licensee's lawful use of the Justice Center Grounds between the hours of 5:00 am and 6:30 am, Monday through Friday (hereinafter "the Event Hours"), unless this Agreement is otherwise terminated under Section V of this Agreement. The temporary license granted by the County under this Agreement is expressly limited to the Term and the Event Hours cited above. Licensee agrees that it will make diligent efforts to limit the number of people allowed onto the Justice Center Grounds at any given time during the Term to fifty (50).

II.

CONSIDERATION

The parties to this Agreement recognize that ample consideration exists to bind them to the terms and obligations contained herein.

III.

MANAGEMENT

Licensee shall be responsible for the management of the Justice Center Grounds during the Event Hours of the Term. Licensee's management responsibilities shall include, but not be limited to: 1) ensuring that the Justice Center Grounds are secure and safe during the Event Hours of the Term for any event(s) that Licensee wishes to have on the County's property, 2) ensuring that crowd control and other safety

precautions are planned in advance of the event(s) and implemented during the event(s), 3) ensuring that any items, improvements, or personal property brought upon the Justice Center Grounds during the Term do not damage the Justice Center Grounds, 4) ensuring that any items, improvements, and/or personal property brought upon the Justice Center Grounds during the Term are safe and secure, considering that the public shall have access to said items, improvements, and/or personal property, 5) ensuring that all activities and/or materials related to the event(s) are properly and legally permitted by any governmental or private authority that has regulation powers over that activity or material, and 6) ensuring that all materials that are brought onto or left on the Justice Center Grounds during the Term, including all trash or litter, are removed after each daily use of the Justice Center Grounds.

IV.

WRITTEN NOTICE OF ACTIVITIES

No later than three (3) business days before the beginning of the Term, Licensee shall provide the County with a written, detailed overview of all events and activities that will occur on the Justice Center Grounds under this Agreement and during the Term. In said overview, Licensee shall also include information regarding: 1) the anticipated number of people attending the event(s) on the Justice Center Grounds and the anticipated times of the event(s), 2) security, if any, that will be provided or arranged by Licensee, and 3) any materials, items, or objects that Licensee intends to bring onto the Justice Center Grounds.

V.

RIGHTS OF THE COUNTY

The County reserves the following rights under this License Agreement: 1) to further limit the time, place, and manner of any activities on the Justice Center Grounds by providing Licensee with a written instruction of how that activity shall be conducted; 2) to prohibit, terminate, restrain, or enjoin any activity on the Justice Center Grounds that was not detailed in Licensee's Written Notice of Activities cited above in Section IV; 3) to prohibit the use of certain materials, items, or other objects that Licensee wishes to bring onto the Justice Center Grounds by providing written notice of that prohibition to Licensee; 4) to require certain action(s) by Licensee that further the health, safety, legality, and security of the Justice Center Grounds, Licensee's event(s) and those individuals attending Licensee's event(s) by providing written notice of that requirement to Licensee; 5) to change the Hours under this Agreement by providing written notice of that change to Licensee; 6) to change the Term under this Agreement by providing written notice of that change to Licensee; and 7) to terminate the License issued under this Agreement by providing ten (10) business days written notice of that termination to Licensee. Licensee recognizes the County's reservation of the above rights, and agrees to comply with the County's written assertion of rights under this Section.

VI.

DEPOSIT

Licensee shall remit payment of Two Hundred United States Dollars (\$200.00 USD) to the County in the form of a Cashier's Check or Money Order, said monies to be held in trust by the County during the Term. The Cashier's Check or Money Order may be deposited into a Caldwell County bank account if the County: 1) determines that Licensee's use of the Justice Center Grounds has caused the County to incur expenses or damages, 2) provides written notice to Licensee, within ten (10) business days of the end of the Term, that Licensee's use of the Justice Center Grounds during the Term has caused the County to incur expenses or damages, 3) provides a written accounting to Licensee, within ten (10)

business days of the end of the Term, that details the expenses or damages incurred, and 4) refunds the remainder of the Licensee's deposit, if any, after subtracting any and all expenses and/or damages incurred from the deposit, such refund to occur within ten (10) business days of the end of the Term. If the County's written accounting to Licensee under this Section exceeds the amount deposited by Licensee, Licensee shall, within a reasonable time, pay the County the difference between the amount claimed by the County and the amount deposited by Licensee, such monies being considered liquidated damages by the parties hereto.

**VII.
INSURANCE**

Licensee is a Texas corporation which maintains a commercial general liability insurance policy with amount(s) sufficient to save, protect and insure Licensee, (or, County, if Licensee indemnifies the County under Section VIII, below) for the Authorized Activity being held in the License Area. Evidence of Licensee's general liability coverage will be provided to County upon request. Furthermore, Licensee agrees to add the License Area as an insured under its liability policy, before the Term is to commence. A copy of this insurance policy is attached as Exhibit "A" and is incorporated herein.

**VIII.
CONTRACTUAL RELATIONSHIP; INDEMNITY**

The County and Licensee are independent contractors under the terms of this Agreement. Nothing in this Agreement shall be construed to mean that Licensee is an agent or employee of the County, nor that the County is an agent or employee of Licensee. Neither Licensee nor the County will be liable for the actions of, or failure to act by, any employee, agent, volunteer, or officer of the other party. Licensee will be responsible for investigating, handling, responding to, and defending claims and causes of action arising from any act, omission or failure to act by Licensee under this agreement. The County will be responsible for investigating, handling, responding to, and defending claims and causes of action arising from any act, omission or failure to act by the County under this agreement. Licensee recognizes that claims and/or causes of action may arise in relation to materials, items, or other objects that are brought onto the Courthouse Grounds by Licensee. TO THE EXTENT ALLOWED BY APPLICABLE LAW, LICENSEE AGREES TO FULLY INDEMNIFY AND HOLD HARMLESS THE COUNTY AGAINST ANY CLAIM OF PREMISE LIABILITY, OR ANY OTHER CLAIMS, LOSSES, DAMAGES, CAUSES OF ACTION, SUITS, OR LIABILITY, IF SUCH CLAIM RELATES TO MATERIALS, ITEMS, OR OTHERS OBJECTS THAT ARE BROUGHT ONTO THE COURTHOUSE GROUNDS BY LICENSEE OR LICENSEE'S AGENTS, EMPLOYEES, VOLUNTEERS, OR OFFICERS.

The parties to this LICENSE AGREEMENT FOR USE OF JUSTICE CENTER GROUNDS hereby agree to the terms and conditions cited above, as is evidenced by their signatures, or the signatures of their lawful representatives, below.

Caldwell County Texas, Licensor
By: Judge Ken Schawe
County Judge
110 S. Main Street, Room 201
Lockhart, Texas 78644

Camp Gladiator, Inc., Licensee
By: _____



CERTIFICATE OF LIABILITY INSURANCE

DATE (MM/DD/YYYY)
09/03/2014

THIS CERTIFICATE IS ISSUED AS A MATTER OF INFORMATION ONLY AND CONFERS NO RIGHTS UPON THE CERTIFICATE HOLDER. THIS CERTIFICATE DOES NOT AFFIRMATIVELY OR NEGATIVELY AMEND, EXTEND OR ALTER THE COVERAGE AFFORDED BY THE POLICIES BELOW. THIS CERTIFICATE OF INSURANCE DOES NOT CONSTITUTE A CONTRACT BETWEEN THE ISSUING INSURER(S), AUTHORIZED REPRESENTATIVE OR PRODUCER, AND THE CERTIFICATE HOLDER.

IMPORTANT: If the certificate holder is an ADDITIONAL INSURED, the policy(ies) must be endorsed. If SUBROGATION IS WAIVED, subject to the terms and conditions of the policy, certain policies may require an endorsement. A statement on this certificate does not confer rights to the certificate holder in lieu of such endorsement(s).

PRODUCER		CONTACT NAME: Kimberly Pierce
Sports & Fitness Insurance Corporation		PHONE (A/C, No, Ext): (800) 844-0536
Post Office Box 1867		FAX (A/C, No): 801-707-1037
Madison MS 39130		EMAIL ADDRESS: kimberly@sportsfitness.com
INSURED		INSURER(S) AFFORDING COVERAGE
Camp Gladiator Inc		INSURER A: General Insurance Company of America
9185 Research Blvd.		INSURER B:
Austin TX 78758		INSURER C:
		INSURER D:
		INSURER E:
		INSURER F:

COVERAGES CERTIFICATE NUMBER: REVISION NUMBER:

THIS IS TO CERTIFY THAT THE POLICIES OF INSURANCE LISTED BELOW HAVE BEEN ISSUED TO THE INSURED NAMED ABOVE FOR THE POLICY PERIOD INDICATED. NOTWITHSTANDING ANY REQUIREMENT, TERM OR CONDITION OF ANY CONTRACT OR OTHER DOCUMENT WITH RESPECT TO WHICH THIS CERTIFICATE MAY BE ISSUED OR MAY PERTAIN, THE INSURANCE AFFORDED BY THE POLICIES DESCRIBED HEREIN IS SUBJECT TO ALL THE TERMS, EXCLUSIONS AND CONDITIONS OF SUCH POLICIES. LIMITS SHOWN MAY HAVE BEEN REDUCED BY PAID CLAIMS.

INSR LTR	TYPE OF INSURANCE	ADDL SUBR INSR WVD	POLICY NUMBER	POLICY EFF (MM/DD/YYYY)	POLICY EXP (MM/DD/YYYY)	LIMITS
A	GENERAL LIABILITY	Y	LSF-9631894C	09/12/2014	09/12/2015	EACH OCCURRENCE \$ 1,000,000
	<input checked="" type="checkbox"/> COMMERCIAL GENERAL LIABILITY					DAMAGE TO RENTED PREMISES (Per occurrence) \$ 1,000,000
	<input type="checkbox"/> CLAIMS-MADE <input checked="" type="checkbox"/> OCCUR					MED EXP (Any one person) \$ 10,000
	<input checked="" type="checkbox"/> Professional Liability Included					PERSONAL & ADV INJURY \$ 1,000,000
	<input checked="" type="checkbox"/> SAM Coverage Included					GENERAL AGGREGATE \$ 2,000,000
	GEN'L AGGREGATE LIMIT APPLIES PER: <input type="checkbox"/> POLICY <input type="checkbox"/> PROJCT <input type="checkbox"/> LOC					PRODUCTS - COMP/OP AGG \$ 2,000,000
						\$
	AUTOMOBILE LIABILITY					COMBINED SINGLE LIMIT (Per accident) \$
	<input type="checkbox"/> ANY AUTO					BODILY INJURY (Per person) \$
	<input type="checkbox"/> ALL OWNED AUTOS	<input type="checkbox"/> SCHEDULED AUTOS				BODILY INJURY (Per accident) \$
	<input type="checkbox"/> HIRED AUTOS	<input type="checkbox"/> NON-OWNED AUTOS				PROPERTY DAMAGE (Per accident) \$
						\$
	UMBRELLA LIAB					EACH OCCURRENCE \$
	EXCESS LIAB	<input type="checkbox"/> OCCUR <input type="checkbox"/> CLAIMS-MADE				AGGREGATE \$
						\$
						\$
	WORKERS COMPENSATION AND EMPLOYERS' LIABILITY					WC STATUTORY LIMITS <input type="checkbox"/> OTHER <input type="checkbox"/>
	ANY PROPRIETOR/PARTNER/EXECUTIVE OFFICER/MEMBER EXCLUDED? (Mandatory in NH)	Y/N <input type="checkbox"/>	N/A			E.L. EACH ACCIDENT \$
	If yes, describe under DESCRIPTION OF OPERATIONS below					E.L. DISEASE - EA EMPLOYEE \$
						E.L. DISEASE - POLICY LIMIT \$

DESCRIPTION OF OPERATIONS / LOCATIONS / VEHICLES (Attach ACORD 101, Additional Remarks Schedule, if more space is required)

See Additional Remarks Schedule Acord 101

CERTIFICATE HOLDER CANCELLATION

Austin ISD 1111 W. 6th Street Austin TX 78703	SHOULD ANY OF THE ABOVE DESCRIBED POLICIES BE CANCELLED BEFORE THE EXPIRATION DATE THEREOF, NOTICE WILL BE DELIVERED IN ACCORDANCE WITH THE POLICY PROVISIONS.
	AUTHORIZED REPRESENTATIVE

AGENCY CUSTOMER ID: 418694

LOC #: _____



ADDITIONAL REMARKS SCHEDULE

Page 2 of 2

AGENCY Sports & Fitness Insurance Corporation		NAMED INSURED Camp Gladiator Inc 9185 Research Blvd.	
POLICY NUMBER SEE CERTIFICATE		Auslin, TX, 78758	
CARRIER SEE CERTIFICATE	NAIC CODE	EFFECTIVE DATE: SEE CERTIFICATE	

ADDITIONAL REMARKS

THIS ADDITIONAL REMARKS FORM IS A SCHEDULE TO ACORD FORM,
 FORM NUMBER: 25 FORM TITLE: CERTIFICATE OF LIABILITY INSURANCE

9185 Research Blvd., Auslin, TX 78758
 Boot Camp
 Certificate holder is an Additional Insured as their Interest may appear. Including the following off-site location: The following off site locations are listed as Certificate holder:
 Fulmore Middle School, 201 Mary St E, Auslin, TX 78704
 Martin Middle School, 1601 Haskell St, Auslin, TX 78702
 Kealing Middle School, 1607 Pennsylvania Ave, Auslin, TX 78702
 Doss Elementary School, 7005 Northledge Dr, Auslin, TX 78731
 Lamar Middle School, 6201 Wynona Ave, Auslin, TX 78757
 St. Elmo Elementary School: 600 W. St. Elmo Rd. Auslin, TX 78746
 Auslin High School: 1716 W. Cesar Chavez, Auslin, TX 78703
 Dawson Elementary: 2504 Durwood Street, Auslin, TX 78704
 Travis High School: 1211 East Oltorf Street, Auslin, TX 78704
 Murchinson Middle School: 3700 N. Hills Drive, Auslin, TX 78731
 Baldwin Elementary School: 12200 Meridian Park Blvd, Auslin, TX 78739
 Kocurek Elementary School: 1009 West Dilmar Road, Auslin, TX 78748

2015.01.20.10 Discussion/Action
to consider purchase of floor cleaning
equipment for the Caldwell County
Justice Center. Price comparison is as
follows: GBC total cost \$10,924.83. Jco
Janitorial Supply total cost \$9,309.00.
Texas Smart Buy total cost \$8,864.17.
Speaker: Commissioner
Roland/Curtis Weber. Backup:3.

CALDWELL COUNTY, TEXAS

PRICE COMPARISONS - JANITORIAL EQUIPMENT

<u>EQUIPMENT DESCRIPTION</u>	<u>GBC</u>	<u>JCO</u>	<u>TX SMART BUY</u>
Model 05342 A Focus II - L20 Auto Scrubber	\$ 6,116.25	\$ 4,295.00 *	\$ 4,402.82
Commercial Vacuum Cleaner - 6qt Backpack	360.65	N/A	386.60
20" Floor Machine 1.5 HP	1,440.99	825.00	940.89
20" High Speed Burnisher - 1500 RPM	956.12	990.00	884.76
12 Gallon Self Contained Carpet Extractor	2,050.82	3,199.00	2,249.10
	<u>\$10,924.83</u>	<u>\$9,309.00</u>	<u>\$8,864.17</u>

* Model PE 320 20" Auto Scrubber

GBC

Curtis Weber

From: <cwallsgbc@gvec.net>
To: <curtis.weber@co.caldwell.tx.us>
Sent: Friday, December 19, 2014 9:49 AM
Attach: 70506A Focus II Mid Size CFS7-12.pdf; 71090A8-11 BOOST Technology CFS.pdf; 71431A Focus II Compact CFS7-12.pdf
Subject: GBC/Floor machines

Curtis Weber / Caldwell County

Please see attached and below:

20"

05361A Focus(r) II L20 BOOST(r) 130 Ah wet batteries, onboard charger, pad holder \$5,534.38

05342A Focus(r) II L20 140 (AGM) batteries, onboard charger, pad holder \$6,116.25

28"

05371A FOCUS(r) II BOOST 28(r) 242 Ah wet batteries, onboard charger, pad holder \$9,871.75

05374A FOCUS(r) II BOOST 28(r) 312 Ah maint-free (AGM) batteries, onboard charger, pad holder \$12,103.00

32"

05381A FOCUS(r) II BOOST(r) 32 242 Ah wet batteries, onboard charger, pad holder \$10,511.38

05384A FOCUS(r) II BOOST(r) 32 312 Ah maint-free (AGM) batteries, onboard charger, pad holder \$12,742.63

We also have a rider unit in this set up if needed.

GRAND TOTAL

\$ 10,924.83



Focus[®] II Mid Size Autoscrubbers[®]

- 6 models to choose from for your application
- Superior solution pick-up
- BOOST[®] is quiet at 63 dB A
- Easy operation
- Environmentally friendly with efficient solution control and usage



Trusted. Reliable. Efficient.

A Nilfisk-Advance Brand

Clarke[®]

The Focus® II Mid Size Autoscrubbers® provide an increased capacity, longer run times, and are easy to operate!

BOOST® Technology



Focus® II Mid Size - BOOST® 28 & 32

BOOST® Technology is the most efficient and green autoscrubber on the market today - the only one that can remove floor finish chemical-free!* BOOST reduces water and chemical use up to 70% by containing the solution within the pad and by delivering a precise and consistent solution in pulses. The unique pad design also cleans into corners, reducing your manpower. Add it all up and it means huge cost and labor savings every day!

*using maroon prep pad



3 Disc Models



Focus® II Mid Size - Disc 26, 28 & 34

Conventional disc models of the Focus® II are available with either a 26, 28 or 34 inch disc scrub deck powered by two heavy-duty brush motors. The disc models are ideal for everyday cleaning. The gimble mounted brushes and pad driver contours uneven floors for even scrubbing agitation.



Cylindrical



Focus® II Mid Size - Cylindrical 28

Ideal for scrubbing grouted tile, imperfect, or rough textured floors. The 28 in cylindrical model provides superior cleaning with wet sweeping capabilities. Debris is conveniently collected into a removable tray by the counter rotating brushes. The brushes are also easy to changeout without using tools.



Easy access to the battery compartment is great for maintenance and installation and designed to contain any liquid spills. Choose either 250 or 330 Ah wet or 260 or 312 Ah AGM batteries.



The optional Chemical Mixing System gauges the appropriate amount of chemical and mixes it into the solution flow. The ounce per gallon setting is controlled by a knob on the control panel.



Quiet vacuum motor system - 65 decibels on disc, 63 decibels on the BOOST model. This allows the operator to use the scrubber in noise sensitive areas.

Focus® II Mid Size Autoscrubber® Features & Benefits:

- **A. Yellow Palm Buttons** - ergonomically placed buttons control forward motion and start the brush motors and solution flow.
- **B. Onboard Battery Charger** - allows the machine to charge anywhere!
- **C. Urethane Squeegee Blades** - best chemical resistance, longer wear, and quiet pickup.
- **D. Adjustable Squeegee Knob** - easy to adjust blades for complete water pickup, no tools!
- **E. Rear Solution Fill** - allows filling while emptying the recovery tank at deep sink facilities.
- Large capacity, 23 gallon recovery and solution tanks - providing longer run times between dump and fills.
- Gimble Mounted Brushes and Pad Drivers - contours uneven floors for even scrubbing agitation.
- Patented Pulse Modulated Solution Control - delivers precise and consistent solution.
- Large diameter, high traction, non-marking foam filled wheels - provides a smoother, slip-free, and quieter operation.
- Quiet 65 decibels (BOOST models at 63 dB A) - operate in sound sensitive areas!

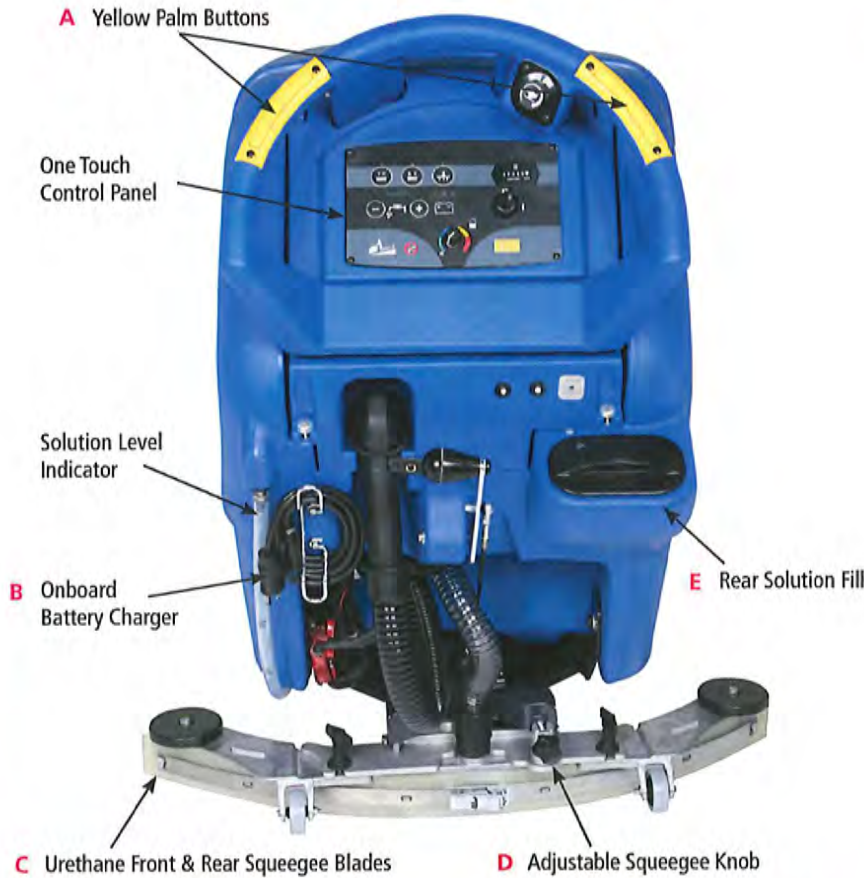

One touch control panel is simple and effortless to operate. Ergonomically placed controls for all functions.



Large opening aids in sanitizing the 23 gallon recovery tank. The electronic float switch shuts off the vac motor when tank is full.



Removable gasket allows the user to sanitize the recovery tank lid.



Optional off-aisle wand kit with telescoping wand for compact storage.



◀ With BOOST Technology, you can remove floor finish without chemicals! You can eliminate chemical costs, eliminate labor, improve indoor air quality and greatly reduce the time spent removing floor finish. Great for medical facilities and schools!

▶ The high speed agitation of BOOST not only has superior cleaning performance, but also wet shines the floor to reduce burnishing requirements.





SPECIFICATIONS	28 BOOST®	32 BOOST®	26 Disc	28 Disc	34 Disc	28 Cylindrical
Part Number	Multiple part numbers, see price book					
Pad/Brush Size	14 x 28 in (35.6 x 71 cm)	14 x 32 in (35.6 x 81 cm)	(2) 13 in (33 cm)	(2) 14 in (36 cm)	(2) 17 in (43 cm)	(2) 5.75 x 28 in (14.5 x 69 cm)
Brush Motor Power / RPM	3/4 hp (0.56 kW) 2,250 RPM		(2) 3/4 hp (0.56 kW) 200 RPM			(2) 0.81 hp (0.6 kW) 613 RPM
Brush Pressure	65 lb (29.5 kg) & 125 lb (56.7 kg)	95 lb (43 kg) & 150 lb (68 kg)	80 lb (36 kg) 150 lb (68 kg)			80 lb (36 kg)
Squeegee Width	35 in (89 cm)	41 in (107 cm)	32.5 in (81 cm)	35 in (89 cm)	41 in (107 cm)	35 in (89 cm)
Battery Power	24 V, (4) 6 V batteries, 250 Ah or 330 Ah wet, plus 260 or 312 AGM's					
Vacuum Motor Power	0.75 hp (550 W) 3 stage tangential discharge					
Solution & Recovery Tank / Fill	23 gal (87 L) each tank / Rear fill with bucket or hose					
Solution Flow	(Normal Mode) 0.12 gal/min (0.45 L/min) (Full Range) 0.0-0.65 gal/min (0.0-2.5 L/min)		0-1 gal/min (0-3.8 L/min)			
Speed (Forward/Reverse)	Forward: 0-260 ft/min (0-4.8 km/hour) / Reverse: 0-174 ft/min (0-3.2 km/hour)					
Wheels	(2) 10.24 in x 3.35 in (260 x 85 mm) Light gray, non-marking, foam filled					
Cleaning Grade	6 degree incline					
Casters	(2) 3.94 in (10 cm) Polyurethane					
Squeegee Material	Urethane front and rear blade					
Charger	Onboard, 24 V, 25 amp					
Sound Level	63 dB A	63 dB A	65 dB A	65 dB A	67 dB A	71 dB A
L x W x H	60.5 x 29 x 44 in	60.5 x 32.75 x 44 in	61 x 28 x 44 in	62 x 30 x 44 in	64 x 36 x 44 in	59.5 x 31 x 44 in
Agency Approval	UL 583					
Warranty	Polydur® Body - 8 Years, Parts - 3 Years, Labor - 1 Year, Battery 18 months pro-rated (1st 90 days unconditional)					

Specifications are subject to change without notice.



Who uses this machine?

- Schools and Universities
- Medical Facilities
- Retail Stores
- Office Buildings
- Hotels and Motels
- Grocery Stores
- Restaurants and Cafeterias
- Athletic Facilities
- Cleaning Contractors

What makes it "green"?

- Low sound level
- Solution conservation
- Onboard battery charger
- Chemical mixing system (optional)
- Ergonomic design

- AGM battery (optional)
- Solution and brush off in neutral
- Low voltage battery protection
- Less or no chemical requirement (BOOST®)
- Chemical-free floor finish removal (BOOST®)
- Reduction in Pad Usage by 40% (BOOST®)

What are the safety features?

- Security key switch
- Safety yellow palm switches
- Thermal overload protection
- Excellent line of sight

What are the accessories?

- Full line of brushes
- Full line of pads
- BOOST® wet screens for gym floor refinishing
- Clarke® Battery Maintenance System
- Chemical Mixing System Kit
- Replacement Squeegee Blade Kits
- Hour Meter Kit
- Off Aisle Wand Kit



recyclable

14600 21st Avenue North • Plymouth, MN 55447-3408
Phone: 800.253.0367 • Fax: 800.825.2753

240 Superior Boulevard • Mississauga, Ontario, Canada L5T 2L2
Phone: 800.668.8400 • Fax: 800.263.5111

©2012 Nilfisk-Advance, Inc. All rights reserved. P/N 70506A 7/12

Clarke®

A Nilfisk-Advance Brand

www.clarkeus.com



BOOST® Technology Autoscrubbers®

- Allows chemical-free floor finish removal
- Multi application technology - cleans floors, removes floor finish, and wet screens gym floors
- 50-70% less solution consumption
- 25% increase in battery run times and 40% increase in pad life
- Available on most Clarke autoscrubbers

BOOST® Technology – Cleans Into Corners Where Others Can't

For years, the most productive way to clean and maintain smooth tile or concrete floors was with a disc automatic scrubber. Depending on the size of the scrub path, there could be dual counter-rotating pads or brushes. Operating at 200-300 rpm, and requiring an increased pad pressure, acceptable results are achieved by a disc scrubber.

An integral part of BOOST Technology is the utilization of a rectangular pad that provides consistent contact across the cleaning path. Whether on a floor machine or autoscrubber, the BOOST pad provides more contact area of the pad on the floor surface, cleaning more uniformly and more consistently than disc scrubbing. The rectangular shape to the BOOST scrub head allows for the operator to clean immediately along the edge of baseboards, as well as in corners.



Trusted. Reliable. Efficient.

A Nilfisk-Advance Brand

Clarke®

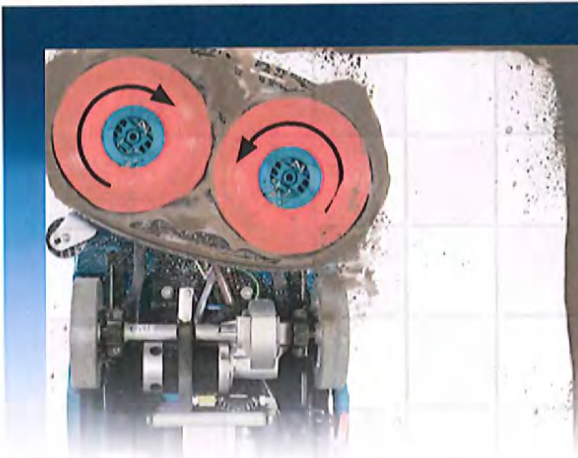
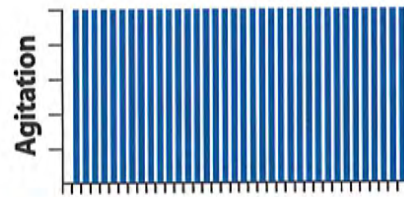
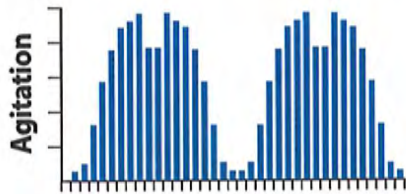

One Way Directional Scrubbing of Conventional Disc Machines

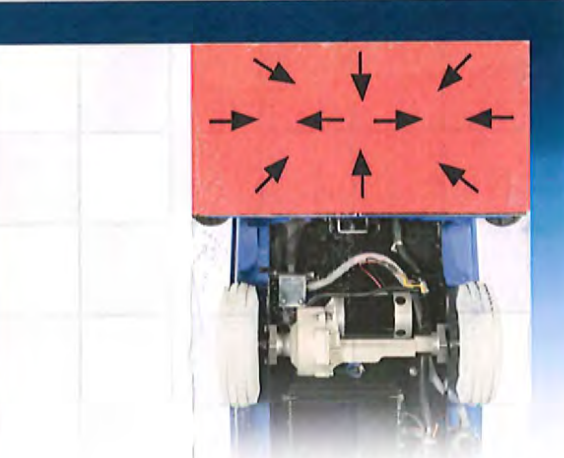

Multi-Directional Scrubbing by BOOST Orbital Pad Scrubber



Reduces Water & Chemical Consumption

Using BOOST® Technology, cleaning solution is introduced in front of the rectangular scrubbing pad with Clarke's patented **Pulse Modulated Solution Control**. The orbital action contains the cleaning solution in the pad and carries it for the full length of the pad. Compared to traditional disc scrubbers that sling water away from the pad, BOOST's efficient use of the cleaning solution results in **water and chemical savings of 50% to 70%**.

Using less water during cleaning keeps the operator working productively rather than in the janitor's closet emptying and refilling the scrubber tanks.

Decreases Strip and Recoat Cycles

Cleaner floors allow for more effective burnishing. Dirt left behind by traditional disc scrubbers is often burnished into the finish, resulting in a yellowing of the finish. With more effective cleaning AND burnishing, the time between labor-intensive strip-and-recoats can be extended, which means less money spent on floor stripping, finishing, and labor.



Strip Your Floors Chemical-Free

Save the money and just use water! That's all you need to remove floor finish. Just put on a maroon pad, fill the tank with clean water and reduce your speed. Using only water also reduces the chance for slip and falls, leaves no fumes and keeps floors dry, safe, and ready for recoating. Imagine the savings you will see in chemicals alone! BOOST® Technology is not only excellent for removing floor finish, but is also great for evenly deep scrubbing floors.

Chemical-free removal of floor finish with BOOST is ideal for use in education and healthcare facilities when air quality and open building areas are critical!



Reduces Floor Pad Consumption

Because BOOST® Technology cleans at orbits 10 times that of a conventional scrubber and attacks dirt from multiple directions, less pad pressure is required to achieve the desired cleaning result. With the combination of high RPM orbital action and reduced pad pressure, the life of your floor pads is extended by up to 40%!

Just think about this. An average 40-store grocery store chain in the Midwest that spends \$30,000 in floor pads a year will now save over \$12,000 per year in pad costs, just by implementing Clarke's BOOST® Technology cleaning method.

Increases Efficiency and Battery Runtimes

With conventional disc floor scrubbers, as much as 30% of an operator's time during a shift is spent emptying the recovery tank and refilling the solution tank. Since these disc scrubbers can use twice the amount of solution, more dump and fills are required during a cleaning shift.



With BOOST®, you'll experience a 15 to 20 minute labor savings for each dump and refill that's eliminated. The BOOST's unique pad shape also allows for close-edge cleaning without overspray, virtually eliminating additional labor steps in cleaning operations.

The reduced water usage coupled with the reduced pad pressure enables the BOOST® machine to utilize the motors and battery pack more efficiently, which translates into an increased run time of up to 25% compared to similar disc scrubbers! By using BOOST® you can reduce the cost of battery replacement and reduce the environmental impact of battery recycling.

Wet Screen Your Gym Floors

After you are done scrubbing and removing floor finish, use BOOST® Technology Scrubbers to wet screen your gym floors!

Wet screening cleans and preps the gym floor surface for lasting adhesion of a new coating. The high speed orbital action and minimal solution usage coupled with fast and immediate solution pickup is the most productive tool in achieving the highest quality gym floor surface.





SPECIFICATIONS	BOS-18 Floor Machine	Focus® II Compact L20	Focus® II Mid Size 28	Focus® II Mid Size 32	CR28 BOOST® Rider	Focus® Rider 32
Part Number	01555A	see price book	see price book	see price book	00345A / 00346A	see price book
Cleaning Pad Size	18 in (45.8 cm)	20 in (50.8 cm)	28 in (71 cm)	32 in (81.3 cm)	28 in (71 cm)	32 in (81.3 cm)
Brush Speed	3,600 RPM	2,250 RPM	2,250 RPM	2,250 RPM	2,250 RPM	2,250 RPM
Brush Pressure	N/A (Floor machine)	40 & 75 lb (18 & 34 kg)	65 & 125 lb (29.5 & 56.7 kg)	95 & 150 lb (43 & 68 kg)	66 lb (30 kg)	115 & 155 lb (52 & 70 kg)
Power Source	Electric	Your choice of wet or AGM batteries				
Scrubbing Flow Rate	Manual	0.1 gal/min	0.12 gal/min	0.12 gal/min	0.17 gal/min	0.15 gal/min
Pad Life	40% longer than disc scrubbers					
Stripping/hour, ft²	2,000	6,000	8,200	9,400	8,200	9,400
Scrubbing/hour, ft²	6,000	17,600	24,600	28,100	36,900	42,200

Specifications are subject to change without notice.

What makes BOOST® Technology Green?

- Uses up to 50-70% less water & chemicals than conventional scrubbers
- AGM batteries on all autoscrubbers (optional)
- Ergonomically designed machines
- Safety features on every scrubber and floor machine
- Sustainable & recyclable machine parts
- Cleans multiple floor types, reducing the need for additional equipment or additional cleaning processes
- Replacement Squeegee Blade Kits
- Chemical Mixing System Kit
- Off-aisle Wand Kit (Focus Mid Size 32, Focus Rider)
- Hour Meter Kit

Options available on autoscrubbers?

- Clarke® Battery Maintenance System
- Full line of BOOST® Pads

See machine product brochure for more detailed specifications and optional features.



Watch BOOST in action at: www.youtube.com
Search: Clarke BOOST



14600 21st Avenue North • Plymouth, MN 55447-3408
Phone: 800.253.0367 • Fax: 800.825.2753

240 Superior Boulevard • Mississauga, Ontario, Canada L5T 2L2
Phone: 800.668.8400 • Fax: 800.263.5111

©2011 Nilfisk-Advance, Inc. All rights reserved. P/N 71090A 7-11

Clarke®

A Nilfisk-Advance Brand

www.clarkeus.com



Focus® II Compact Autoscrubbers®

- 3 models to choose from
- Superior solution clean up
- Quiet operation at 65.8 dB A
- Easy operation
- Environmentally friendly

The Focus II models are the first 20 in. autoscrubbers available with Clarke's revolutionary BOOST® Technology. If you demand high levels of cleaning with the ultimate in green benefits, BOOST technology offers 70% reduction in water and chemicals, 40% increase in pad life, and an added benefit of chemical-free removal of floor finish, compared to traditional disc models.

No other manufacturer comes close to matching Clarke's combination of serious cleaning ability and green benefits in autoscrubbers. The Focus II models are also available in 2 disc models. And all of the Focus II scrubbers feature important benefits such as low noise levels, improved user ergonomics, onboard chargers, breakaway squeegees and more.



The Focus II Compact BOOST features high speed orbital action and agitation.

Trusted. Reliable. Efficient.

A Nilfisk-Advance Brand

Clarke®

The Clarke Focus II Has 3 Models Available!

The L20 BOOST Orbital, S20 and L20 Disc to fill all application needs

BOOST Orbital



Focus II - BOOST L20

BOOST technology produces high speed agitation with small 1/4 in. orbits. The orbital scrubbing action cleans 6x more effectively than traditional disc scrubbers. That means not only chemical-free removal of floor finish*, but huge cost and labor savings every day: up to 70% less water usage and chemical costs, 50% less dump-and-fill time, and 40% longer pad life!

*using maroon prep pad



2 Disc Models



Focus II S20 with Brush Assist Traverse L20 with Power Traverse

Conventional disc models of the Focus II are available with a 20 inch disc scrub deck. They may be selected with either power traction or brush assist drive. The brush/pad driver installation and removal is made simple with an easy on/off push button control.



The high speed agitation of BOOST not only has superior cleaning performance, but also wet shines the floor to reduce burnishing requirements.



Easy access to battery compartment is great for maintenance and installation. Choose either 130 AH wet or 114 AH AGM batteries.



One-touch control panel is simple and effortless to operate. Ergonomically placed controls for all functions.



Rugged Polydur® tanks withstand impact and resists chemical damage

Large opening aids in clean out of recovery tank

Convenient front and rear fill

Powerful 3/4 HP motor drives the high speed orbital agitation of the BOOST model

Large diameter, non-marking wheels provide high traction

Clarke's patented pulse solution control applies an accurate and conservative amount of solution

Very Quiet - Only 65.8 dB A

Two scrub decks to choose from to fit your application: 20 in. BOOST and 20 in. disc. As shown with BOOST.

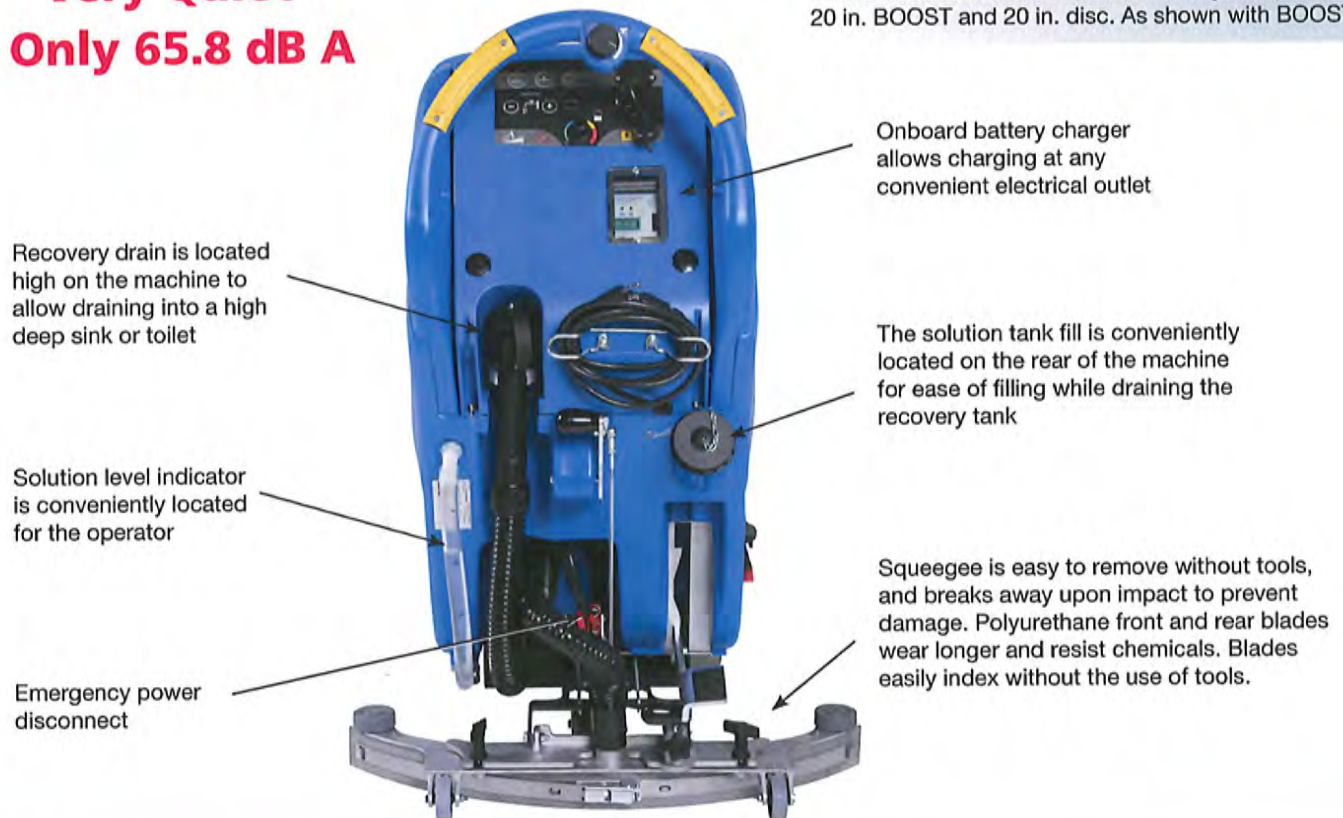

Recovery drain is located high on the machine to allow draining into a high deep sink or toilet

Solution level indicator is conveniently located for the operator

Emergency power disconnect

Onboard battery charger allows charging at any convenient electrical outlet

The solution tank fill is conveniently located on the rear of the machine for ease of filling while draining the recovery tank

Squeegee is easy to remove without tools, and breaks away upon impact to prevent damage. Polyurethane front and rear blades wear longer and resist chemicals. Blades easily index without the use of tools.



SPECIFICATIONS	S20	L20	BOOST L20
Part Number	See price catalog for part numbers		
Scrub Head Type	Disc	Disc	BOOST
Cleaning Width	20 in	20 in	20 in
Drive Type	Drive Assist	Power Traction	
Working Voltage	24 V DC		
Standard Batteries (2)	12 V 130 Ah @ 20 hr rating (wet) or 12 V 114 Ah @ 20 hr rating (AGM)		
Battery Protection System	Low voltage cut-off of brush and solution		
Vacuum Motor Power	0.5 hp, 2-stage tangential discharge		
Solution & Recovery Tank	14.5 gal		
Solution Flow	0 - 0.63 gal/min	0 - 0.3 gal/min*	
Brush Motor Power	0.7 hp (480 W)	0.75 hp (560 W)	
Brush Pressure	45 & 90 lb	40 & 75 lb	
Disc, Pad, Brush Sizes	20 in	14 x 20 in	
Brush Speed	153 RPM	2,250 RPM	
Sound Level	65.8 dB A		
Onboard Charger	Standard		
Dimensions	52 in x 29 in x 42 in	51 in x 29 in x 42 in	
Width (without squeegee)	21 in	20 in	
Squeegee Width	29.9 in		
Agency Approval	cETLus		
Warranty	Polydur Body - 8 Years, Parts - 3 Years, Labor - 1 Year Batteries - 18 months prorated (90 days unconditional)		

*BOOST normal operating flow rate is 0.1 gal/min. Specifications are subject to change without notice.



What enhances its productivity?

- Efficient utilization of solution
- Compact design, large capacity
- Easy on/off brush
- Long run times
- Solution and brush off in neutral

What makes it "green"?

- Low sound level
- Ergonomic design

- AGM battery (optional)
- Chemical-free floor finish removal with BOOST® Technology

What are the safety features?

- Security key switch
- Safety yellow palm switches
- Circuit breaker protection

What are the accessories?

- Full line of brushes and pads
- Battery Maintenance System
- Replacement Squeegee Blade Kit
- Hour meter kit



14600 21st Avenue North • Plymouth, MN 55447-3408
Phone: 800.253.0367 • Fax: 800.825.2753

240 Superior Boulevard • Mississauga, Ontario, Canada L5T 2L2
Phone: 800.668.8400 • Fax: 800.263.5111

©2012 Nilfisk-Advance, Inc. All rights reserved. P/N 71431A 7/12

Clarke®

A Nilfisk-Advance Brand

www.clarkeus.com









Curtis Weber

From: <cwallsgbc@gvec.net>
 To: <curtis.weber@co.caldwell.tx.us>
 Sent: Friday, December 19, 2014 10:32 AM
 Attach: EUR 412.jpg; Pro-2000-20 Burnisher.jpg; Pro-175-21.jpg; MFMPRO-12-100-2.jpg
 Subject: Floor Machine / Quote
 EUR 412 - Comm Bckpk Vacuum Rd 11.5-liter Electrolux Sanitaire® Commercial Backpack Vacuum. Sold by the Each

TOTAL ALL
 \$ 4,808.58

Description

EUR 412 -- Sanitaire® Quiet Clean 6-Qt. Commercial Backpack Vacuum Backpack vacuum includes a powerful 11.5-amp, 120 CFM motor that provides superior Quiet Clean operation at only 69dB. Lightweight—only 11.5-lbs. Features HEPA filtration and 1.5-gal. dirt capacity. Attachments include metal wands, carpet nozzle, deluxe floor and wall brush, dusting brush, crevice tool, deluxe stretch hose and upholstery tool. 50-ft. detachable power cord. Uses disposable bag EUR 62370 (sold separately). Certified by the Carpet and Rug Institute's Seal of Approval program. HEPA filtration captures 99.97% of allergens and and pollen down to 0.3 microns. Meets requirements set by LEED guidelines. Manufacturer's two-year warranty for commercial use. UL Approved for commercial use. Sold by the Each.

List Price: \$454.22

Caldwell Co. / \$360.65 /ea

Item Number EUR 412

EUR 412 - Comm Bckpk Vacuum Rd 11.5-liter Electrolux Sanitaire® Commercial Backpack Vacuum. Sold by the Each

Pro-2000-20 Ultra High-Speed Burnisher

by MERCURY FLOOR MACHINES

Pro-2000-20 Ultra High-Speed Burnisher

List Price: \$1737.85

Caldwell Co. / \$1440.99 / ea

Specifications for this item

Product Description

PRO-2000-20 Features: -Burnisher.-High-speed buffer.-High-powered, D/C rectified motor.-Precision-balanced all-metal chassis.-Interlocked safety switch.-Low-profile apron with full-coverage bumpers.-Fully adjustable handle.-Non marking, retractable 6" wheels. Dimensions: -Dimensions: 1.42" H x 3.33" W x 2.08" D.

Brand Name
 MERCURY FLOOR MACHINES

Number of Items

1

Part Number

PRO-2000-20

Retail: \$1,339.50

Price: Caldwell Co. / \$956.12 / ea

Product Specifications

Floor Machines Type:Roto-ScrubberHandle Type:T-GripBrush Diameter:20"Power Capacity:1.5 hpMaximum Rotation Speed:175 rpmCord Length:50 ftBrush RPM:175 rpmQuantity:1 eachCompliance Standards:UL ListedPre-Consumer Recycled Content Percent:0%Post-Consumer Recycled Content Percent:0%Total Recycled Content Percent:0%

Mercury Floor Machines PRO-175-21 Floor Machine1.5hp+ Shopping List Item

#: MFMPRO21 Write Review FREE Shipping on this item

Includes inside delivery to business addresses

Description: Precision-balanced, heavy-duty 66-frame motor ensures reliable, professional-quality performance. Triple-planetary, high-torque transmission stands up to tough tasks, while minimizing gear wear.

Safety-enhanced, interlocking auto-cutoff switch.

•Floor machine.

•Precision-balanced, heavy-duty 66-frame motor.

•Triple-planetary, high-torque transmission.

•Safety-enhanced interlocking switch.

•Nonmarking, full-wrap bumpers.

•Fully adjustable handle.

•Smooth-rolling 6-inch wheels.

•Manufacturer's limited five-year warranty

Pro-12 12 Gallon Carpet Extractor - MFMPRO121002

List Price: \$2,865.00

Caldwell Co. / \$2050.82 / ea

Mercury Carpet Extractor Cleans Up To 600 Square Feet Without Moving.

Carpet extractor features an easy-to-fill 12 gallon detergent solution tank and quick-dump 12 gallon recovery tank. Powerful solution pump delivers a steady supply of extracting solution to the carpet. Dual high-velocity vacuum motors offer 160" of water lift for faster carpet drying. Motor features air flow design for improved cooling. 25" L vacuum and solution hoses help clean up to 600 sq. ft. without moving extractor. 10" semi-pneumatic wheels allow stair climbing. Strong steel wand has 9" W vacuum head and dual spray jets. 5 Year Limited Warranty. Non-Returnable.

Product Specifications

CAPACITY GALLONS12

BRANDMercury

CLEANING WIDTH9

DESCRIPTIONCarpet Extractor

HOSE LENGTH25

MANUFACTURERS PART NUMBERMFM PRO-12-100-2

WATER LIFT INCHES160

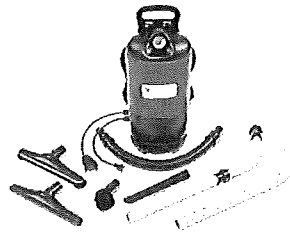

\$ 360.65

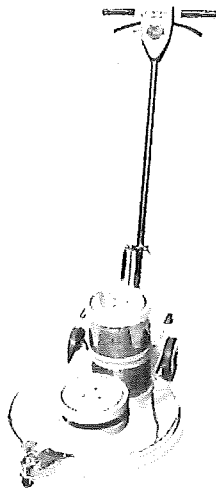

~~\$ 1737.85~~

\$ 1440.99

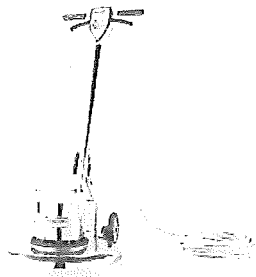

~~1339.50~~

956.12



\$2050.82



JCO

Larry Roberson

From: Curtis Weber <curtis.weber@co.caldwell.tx.us>
Sent: Wednesday, January 14, 2015 4:29 PM
To: Elizabeth Larivee; larry robertson
Cc: j.roland60@yahoo.com
Subject: CCJC equipment
Attachments: TP2010_gde.jpg; backpack_gde.jpg; PE200BU_DATA_SHEET_EN.pdf

List of the equipment. Hope this helped.

Larry should have the Gov. pricing this is just Jco. supply Pricing

20" PE 320 with wet batteries \$4295.00Best price and equipment

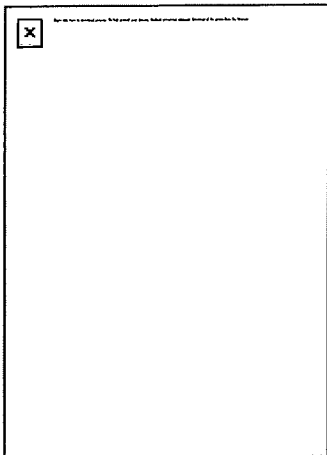

TP-2010
00-4468-5

- Brush speed: 175 RPM
- Pad size: 20"
- Motor: Precision balanced powerful 1.0 Hp
- Power Cord: 50 ft
- 3 wire grounded 14 gauge
- Handle: Durable chromed 13 gauge steel 1 1/4" diameter
- Wheels: 5" non marking 1 1/2 inch axle with sealed double ball bearings
- Shipping weight: 116 lb
- Net weight: 99 lb
- Shroud: Reinforced epoxy powder coated steel
- Chassis: Cast iron
- UPC: 099053044680 \$899.95 Pad driver \$59.95 freight \$75

Here are prices for a PE 200 BU High Speed 1.5 HP 20" 1500 RPM Burnisher (bare bones) \$990 plus freight (approx \$125)
with a vaccuum system \$1195

<http://www.edic-usa.com/index.php/products/self-contained-extractors/supernova/supernova-45.html>
SUPER NOVA 1200 PSN \$3199 PLUS APPROX \$200 FREIGHT

Backpack Vacuum Cleaner

The new Koblenz backpack was specially designed to clean more with less downtime. The back plate support and the full padded shoulder straps were ergonomically designed to assure the operator maximum comfort. Ideal for vacuuming high traffic areas, schools, conference rooms, office buildings and much more.

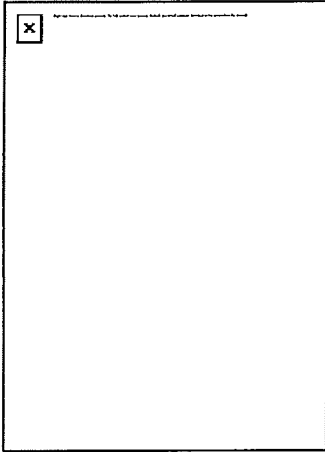

• BP-1400

- Watts: 1400 W
- CFM: 120
- Water Lift: 90"
- Net Weight: 11 lb
- Shipping Weight: 25 lb
- Dust capacity: 6 qts
- Length cord: 50' pigtailed
- Filtration: 4 stage filtration system
- UPC: 099053011866 \$\$489.00 plus fright \$25

Curtis Weber
405 Market. St.
Lockhart Tx, 78644
Cell 512-738-1508
Fax 512-398-1837
curtis.weber@co.caldwell.tx.us

PE200BU

ELECTRIC BURNISHER

- 1 Non-conductive, commercial grade switch housing.
- 2 Toggle flip adjustable handle for easy operation.
- 3 Full pad-to-floor contact with no compensating castor.
- 4 Flexible pad driver.
- 5 Dual lever on/off safety switch for left or right hand operation.
- 6 5" (13 cm) non-marking, self-lubricating operating wheels.
- 7 4" (10 cm) non-marking, self-lubricating transport wheels.
- 8 75 ft. (23 m) 12/3 cord for maximum maneuverability.
- 9 No slip, deep V-belt drive transmission.
- 10 1.5 HP D.C. rectified motor .

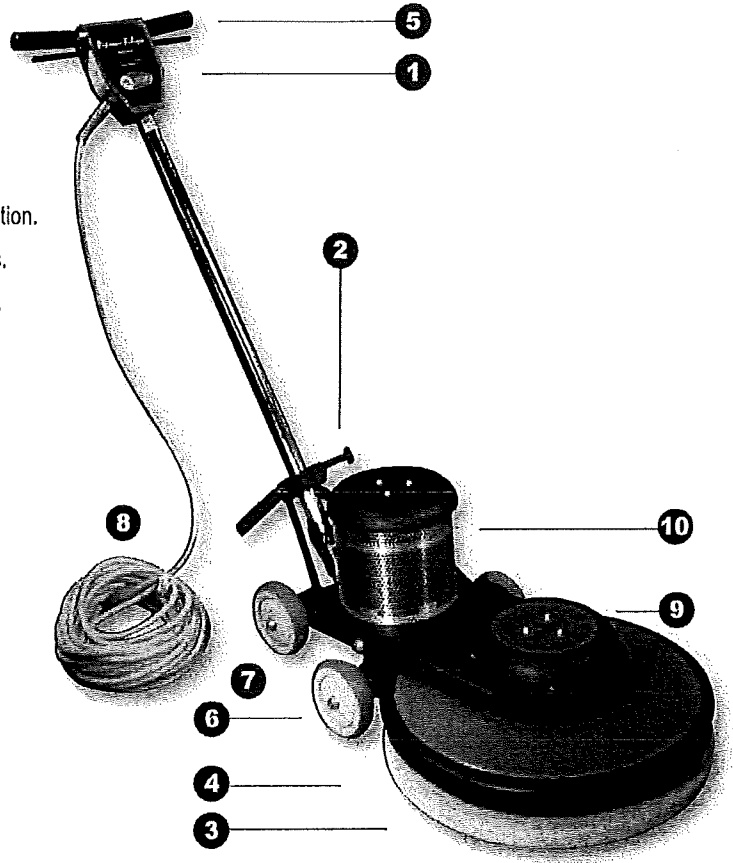

Solid and durable

Rugged construction

All metal construction.

High performance

1500 rpm

Available for 110V power supply.

shine on.

Dimensions and Performance Specifications

Operating Width	Performance	Pad Size	Pad Speed	Power Supply	Noise Level	Weight
20" (51 cm)	15,000 ft ² /hr (1380 m ² /hr)	20" (51 cm)	1500 RPM	110V	62 dB (A)	101 lb (46 kg)

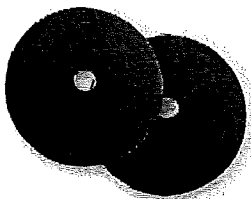

PowerPolish™ & PowerPolish HT™ pads are ideal for curing PowerStar® Top Shield coating on concrete surfaces.

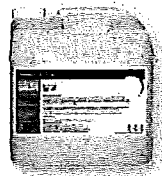

EnviroStar Green® floor coatings for all types of floor surfaces are effective environmentally preferred chemicals.

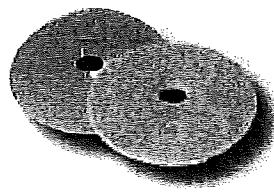

Blue Blend™ and Thermal Thunder™ pads remove scuffs and scratches for a brilliant wet look shine.

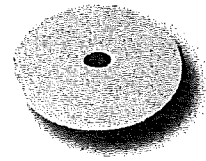

White Lightning™ curing pads provide optimum appearance on soft or fresh coatings.

Pioneer Eclipse®

© 2012 Amano Pioneer Eclipse Corporation • 1 Eclipse Road • PO Box 909 • Sparta, NC 28675 USA
1-800-367-3550 • 1-336-372-8080 • Fax: 1-336-372-2895 • www.pioneer-eclipse.com

Larry Roberson

From: Curtis Weber <curtis.weber@co.caldwell.tx.us>
Sent: Wednesday, January 14, 2015 11:23 AM
To: larry robertson; Marie Cavanagh
Cc: j.roland60@yahoo.com
Subject: Jco supply

This is the pricing i got from JCO supply

14" PE 300 As is \$2299.00
20" PE 320 with wet batteries \$4295.00Best price and equipment!
20" PE 310 with wet batteries \$3995.00

Plus freight. The delivery time is probably 1 week

Here are prices for a PE 200 BU High Speed 1.5 HP 20" 1500 RPM Burnisher (bare bones) \$990 plus freight (approx \$125)
with a vaccuum system \$1195

Low speed 17" 1.5 HP 175 RPM with pad driver \$ 795.00 plus freight approx \$125
20" 1.5 HP 175 RPM with pad driver \$825 plus frieght as above.

These are both Pioneer Eclipse which for the money is my best line Cadillac for the price of a Chevy. I have some Kia pricing that I am working on and will get you very soon as well.

<http://www.edic-usa.com/index.php/products/self-contained-extractors/supernova/supernova.html>
SUPERNOVA 800 PSN \$2799 PLUS APPROX \$200 FREIGHT

<http://www.edic-usa.com/index.php/products/self-contained-extractors/supernova/supernova-45.html>
****SUPER NOVA 1200 PSN \$3199 PLUS APPROX \$200 FREIGHT****

<http://www.edic-usa.com/index.php/products/self-contained-extractors/polaris/polaris701-302.html>
POLARIS 700PS 1795.00 PLUS APPROX \$175 FRIEGHT

<http://www.edic-usa.com/index.php/products/self-contained-extractors/fivestar/fivestar.html>
FIVE STAR 401 TR \$1295 PLUS APPROX FREIGHT \$150

<http://www.edic-usa.com/index.php/products/self-contained-extractors/comet-self-contained-extractors/comet-419tr.html>
COMET \$1095 PLUS APPROX FREIGHT \$150

THEIR ARE OPTIONAL TOOL KITS AND HOSE ASSEMBLY AND WANDS FOR NEARLY ALL OF THESE BUT ARE ADDITIONAL PRICES AND FREIGHT.

WE HAVE SOLD A LOT OF THIS STYLE BECAUSE IT IS SOOOOO EASY TO MANUEVER WITH THE BIG WHEELS AND IT IS SELF CONTAINED. THE ORIGINAL SUPERNOVA'S HAD E BLADDERS THAT IT WOULD BE AN EXCHANGE SYSTEM MEANING YOU WOULD START OUT WITH EXTRACTION CHEMICAL AND THE VACUUMED UP PART WOULD BE EMPTY AND WOULD BE FILLING AS THE EXTRACTION PART WOULD EMPTY. THEY HAVE CHANGED THE DESIGN IN LOOKS SINCE WE LAST BOUGHT ONE. BUT OVER 20 YEARS THE STEALTH IS JUST ABOUT THE ONLY ONE THAT WE HAVE SOLD.... THIS IS A CADILLAC LINE AT A CHEVY PRICE. FOR 10 YEARS WE HAD A STEALTH IN STOCK AND SOLD ONE EVERY YEAR AND THE ONLY ONE THAT I HAVE EVER GOTTEN BACK WAS TO HAVE A BLADDER REPLACED BECAUSE SOMEONE RIPPED IT.... LET ME KNOW IT IS ABOUT 1 WEEK TO GET THIS IN. THANKS CURTIS..

On Tue, Jan 13, 2015 at 8:42 AM, Debby Gibson <jcosupply1@gmail.com> wrote:
Here is the info on the "Kia" Line - same kind of thing approx. a week to get in. plus freight but the freight is about half per machine so approx. \$75 each for burnishers because it is coming from a lot closer...

Commercial Floor Machines

- Triple planetary all steel gears
- Durable all metal construction
- Cast iron base
- Non marking, sealed, double ball bearing wheels and wrap around bumper guard
- Cool running, continuous operating heavy duty motor
- The best modern technology can make
- Will start with low voltage
- Safety switch and locking mechanism, protection against operator error
- 13 gauge chrome steel handle
- Simple, easy to operate and adjust, no operator fatigue
- Easy to use handle clamp (TP models only)
- Large fine adjustment wheel and lock handle
- 3 year limited warranty on motor and transmission!
- 3 year limited warranty on parts & workmanship

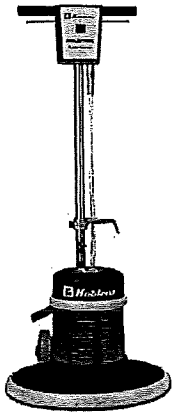

TP-1715
00-4467-7

- Brush speed: 175 RPM
- Pad size: 17"
- Motor: Precision balanced powerful 1.5 Hp
- Power Cord: 50 ft
- 3 wire grounded 14 gauge
- Handle: Durable chromed 13 gauge steel 1 ¼" diameter
- Wheels: 5" non marking 1 ½ inch axle with sealed double ball bearings
- Shipping weight: 123 lb
- Net weight: 96 lb
- Shroud: Reinforced epoxy powder coated steel
- Chassis: Cast iron
- UPC: 099053044673 \$839.95 pad driver is separate Pad Driver \$49.95 freight approx \$75.00

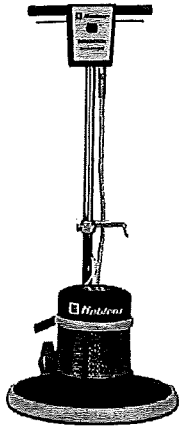

TP-2010
00-4468-5

- Brush speed: 175 RPM
- Pad size: 20"
- Motor: Precision balanced powerful 1.0 Hp
- Power Cord: 50 ft
- 3 wire grounded 14 gauge
- Handle: Durable chromed 13 gauge steel 1 ¼" diameter
- Wheels: 5" non marking 1 ½ inch axle with sealed double ball bearings
- Shipping weight: 116 lb
- Net weight: 99 lb
- Shroud: Reinforced epoxy powder coated steel
- Chassis: Cast iron
- UPC: 099053044680 \$899.95 Pad driver \$59.95 freight \$75

ABOVE ARE LOW SPEEDS

HIGH SPEED

Commercial High Speed Burnishers

- Fast burnishing with less effort
- Full pad contact and ultra smooth balanced operation
- Durable all - metal construction
- Stair climber wheels
- Special handle design for easier storage
- 3 year motor warranty

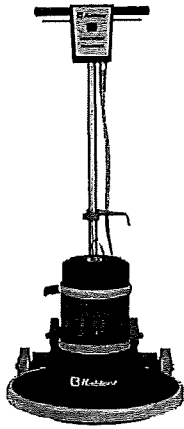

B-1500 FP
00-4493-3

- o Pad Size: 20 inches
- o Motor: 1.5 Hp AC twin capacitor
- o Circuit Breaker
- o Power Cord: 50 ft . 3 wire grounded 14 gauge
- o Handle: FLOATING, durable chromed 13 gauge steel 1 1/4" diameter
- o Wheels: Four 5" non - marking wheels
- o Shipping Weight: 145 lbs
- o Net Weight w/o cable: 120 lbs
- o Shroud: Epoxy powder coated steel
- o Chassis: Cast aluminum
- o UPC: 099053044932 with pad driver 925.00 plus freight \$75

Backpack Vacuum Cleaner

The new Koblenz backpack was specially designed to clean more with less downtime. The back plate support and the full padded shoulder straps were ergonomically designed to assure the operator maximum comfort. Ideal for vacuuming high traffic areas, schools, conference rooms, office buildings and much more.



BP-1400

- Watts: 1400 W
- CFM: 120

- Water Lift: 90"
- Net Weight: 11 lb
- Shipping Weight: 25 lb
- Dust capacity: 6 qts
- Length cord: 50' pigtailed
- Filtration: 4 stage filtration system
- UPC: 099053011866 \$489.00 plus fricht \$25

Curtis Weber
405 Market. St.
Lockhart Tx,78644
Cell 512-738-1508
Fax 512-398=1837
curtis.weber@co.caldwell.tx.us

STATE



Glenn Hegar Texas Comptroller of Public Accounts

(http://www.window.state.tx.us/)

Welcome, Roberson, Larry



(/)

Search:

Commodity Code, Supplier Part #, NIGP or Keyword

Contracts Reports Help (/help)



0 items

Back To Search Results

05342A CLARKE FOCUS II L20 140 AGM

Description: Walk behind auto scrubber 140 ah AGM maint free batteries onboard charger 20" disc scrub path, power traverse forward and backward, with one pad holder. Quite 65.8 dBA, 14.5 gallon tanks. Solution flow 0 - .63 gal/min. brush pressure 45/90 lbs.

Item Details

Price: \$4,402.82
UOM: EA
Qty Per UOM: 1
Contractor: Nilfisk-Advance, Inc.-TXMAS
Contract Number: TXMAS-7-73010 (/contracts/view/898)
Contract Type: TXMAS
Commodity Code: 36560
Min. Order Quantity: 1
Delivery Days: 30
NIGP Code: 36560
Item Availability Start Date: 12/11/2006
Item Availability End Date: 6/30/2018
Supplier Part Number: 05342A

Manufacturer: Nilfisk Advance Inc

Add to cart (</product/2829266?itemdetail>)

[Texas.gov \(http://www.texas.gov/en/Pages/default.aspx\)](http://www.texas.gov/en/Pages/default.aspx)

[Statewide Search from the Texas State Library \(https://www.tsl.state.tx.us/trail/index.html\)](https://www.tsl.state.tx.us/trail/index.html)

[State Link Policy \(http://www.dir.texas.gov/pubs/pages/weblink-privacy.aspx\)](http://www.dir.texas.gov/pubs/pages/weblink-privacy.aspx)

[Texas Homeland Security \(http://governor.state.tx.us/homeland\)](http://governor.state.tx.us/homeland)

[Texas Transparency \(http://www.texas Transparency.org/\)](http://www.texas Transparency.org/)

[Report Fraud \(http://www.window.state.tx.us/fraud.html\)](http://www.window.state.tx.us/fraud.html)

Glenn Hegar, Texas Comptroller • Window on State Government (<http://www.window.state.tx.us/>) • Contact Us (<http://www.window.state.tx.us/contact.html>)

[Privacy and Security Policy \(http://www.window.state.tx.us/privacy.html\)](http://www.window.state.tx.us/privacy.html)

[Accessibility Policy \(http://www.window.state.tx.us/accessibility.html\)](http://www.window.state.tx.us/accessibility.html)

[Link Policy \(http://www.window.state.tx.us/linkpolicy.html\)](http://www.window.state.tx.us/linkpolicy.html)

[Public Information Act \(http://www.window.state.tx.us/pia.html\)](http://www.window.state.tx.us/pia.html)

[Texas Veterans Portal \(http://veterans.portal.texas.gov/en/Pages/default.aspx\)](http://veterans.portal.texas.gov/en/Pages/default.aspx)

[Compact with Texans \(http://www.window.state.tx.us/comptrol/compact/\)](http://www.window.state.tx.us/comptrol/compact/)



SPECIFICATIONS	S20	L20	BOOST L20
Part Number	See price catalog for part numbers		
Scrub Head Type	Disc	Disc	BOOST
Cleaning Width	20 in	20 in	20 in
Drive Type	Drive Assist	Power Traction	
Working Voltage	24 V DC		
Standard Batteries (2)	12 V 130 Ah @ 20 hr rating (wet) or 12 V 114 Ah @ 20 hr rating (AGM)		
Battery Protection System	Low voltage cut-off of brush and solution		
Vacuum Motor Power	0.5 hp, 2-stage tangential discharge		
Solution & Recovery Tank	14.5 gal		
Solution Flow	0 - 0.63 gal/min	0 - 0.3 gal/min*	
Brush Motor Power	0.7 hp (480 W)	0.75 hp (560 W)	
Brush Pressure	45 & 90 lb	40 & 75 lb	
Disc, Pad, Brush Sizes	20 in	14 x 20 in	
Brush Speed	153 RPM	2,250 RPM	
Sound Level	65.8 dB A		
Onboard Charger	Standard		
Dimensions	52 in x 29 in x 42 in		51 in x 29 in x 42 in
Width (without squeegee)	21 in		20 in
Squeegee Width	29.9 in		
Agency Approval	cETLus		
Warranty	Polydur Body - 8 Years, Parts - 3 Years, Labor - 1 Year Batteries - 18 months prorated (90 days unconditional)		

*BOOST normal operating flow rate is 0.1 gal/min. Specifications are subject to change without notice.



What enhances its productivity?

- Efficient utilization of solution
- Compact design, large capacity
- Easy on/off brush
- Long run times
- Solution and brush off in neutral

What makes it "green"?

- Low sound level
- Ergonomic design

- AGM battery (optional)
- Chemical-free floor finish removal with BOOST® Technology

What are the safety features?

- Security key switch
- Safety yellow palm switches
- Circuit breaker protection

What are the accessories?

- Full line of brushes and pads
- Battery Maintenance System
- Replacement Squeegee Blade Kit
- Hour meter kit



14600 21st Avenue North • Plymouth, MN 55447-3408
Phone: 800.253.0367 • Fax: 800.825.2759

240 Superior Boulevard • Mississauga, Ontario, Canada L5T 2L2
Phone: 800.668.8400 • Fax: 800.263.5111

©2012 Nilfisk-Advance, Inc. All rights reserved. PN 71431A 7/12

Clarke®

A Nilfisk-Advance Brand

www.clarkeus.com



Glenn Hegar Texas Comptroller of Public Accounts

[\(http://www.window.state.tx.us/\)](http://www.window.state.tx.us/)

Welcome, Roberson, Larry



(1)

Search:

[Contracts](#) [Reports](#) [Help \(/help\)](#)

0 items

[Back To Search Results](#)

Tornado 12 Gallon Self Contained Carpet Extractor

Description: Tornado® 12 Gallon Self-Contained Extractor - 12 Gallon Solution Tank - 14 Gallon Recovery Tank - 100 Lbs - 100 PSI Solution Pump -112 CFM Air Flow Rate - 117" Water Lift - 2 HP, 2-Stage Vacuum Motor - 50' Cord - Use With 180826 Hose (Not Included) - Mfg #98168 - Factory Direct and Freight Charges Apply. Lead Times Vary. Call 877-694-4932 to inquire

Item Details

Price: \$2,249.10**UOM:** EA**Qty Per UOM:** 1**Contractor:** HD Supply Facilities Maintenance, Ltd.**Contract Number:** TXMAS-14-51V010 (/contracts/view/381)**Contract Type:** TXMAS**Commodity Code:** 44543**Delivery Days:** 30**NIGP Code:** 44543**Item Availability Start Date:** 1/25/2014**Item Availability End Date:** 9/29/2015**Supplier Part Number:** 180841

Manufacturer Part #: 98168
Manufacturer: Tornado
Order in Increment Quantity: 1
UNSPSC: 47121609

Add to cart (/product/3071420?itemdetail)



[Texas.gov \(http://www.texas.gov/en/Pages/default.aspx\)](http://www.texas.gov/en/Pages/default.aspx)

[Statewide Search from the Texas State Library \(https://www.tsl.state.tx.us/trail/index.html\)](https://www.tsl.state.tx.us/trail/index.html)

[State Link Policy \(http://www.dir.texas.gov/pubs/pages/weblink-privacy.aspx\)](http://www.dir.texas.gov/pubs/pages/weblink-privacy.aspx)

[Texas Homeland Security \(http://governor.state.tx.us/homeland\)](http://governor.state.tx.us/homeland)

[Texas Transparency \(http://www.texas Transparency.org/\)](http://www.texas Transparency.org/)

[Report Fraud \(http://www.window.state.tx.us/fraud.html\)](http://www.window.state.tx.us/fraud.html)

Glenn Hegar, Texas Comptroller • Window on State Government (http://www.window.state.tx.us/) • Contact Us (http://www.window.state.tx.us/contact.html)

[Privacy and Security Policy \(http://www.window.state.tx.us/privacy.html\)](http://www.window.state.tx.us/privacy.html)

[Accessibility Policy \(http://www.window.state.tx.us/accessibility.html\)](http://www.window.state.tx.us/accessibility.html)

[Link Policy \(http://www.window.state.tx.us/linkpolicy.html\)](http://www.window.state.tx.us/linkpolicy.html)

[Public Information Act \(http://www.window.state.tx.us/pia.html\)](http://www.window.state.tx.us/pia.html)

[Texas Veterans Portal \(http://veterans.portal.texas.gov/en/Pages/default.aspx\)](http://veterans.portal.texas.gov/en/Pages/default.aspx)

[Compact with Texans \(http://www.window.state.tx.us/comptrol/compact/\)](http://www.window.state.tx.us/comptrol/compact/)



Glenn Hegar Texas Comptroller of Public Accounts

(http://www.window.state.tx.us/)

Welcome, Roberson, Larry

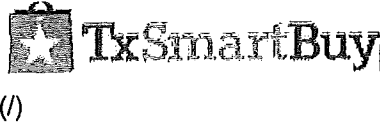

Search:

Commodity Code, Supplier Part #, NIGP or Keyword

[Contracts](#) [Reports](#) [Help \(/help\)](#)

0 items

[Back To Search Results](#)

Backpack Vacuum Cleaner 6 qt. 10.2A

Description: Backpack Vacuum Cleaner Amps 10.2 Air Flow 120 cfm Series Commercial Tank Size 6 qt. Filter Type HEPA Static Pressure 110 In. Net Weight 9.5 lb. Cord Length 50 ft. Voltage 120 Watts 1175 Number of Motor Stages 1-Stage Diameter 9-1/2 In. Height 22 In. Hose Dia 1-1/2 In. Hose Length 4 ft. Hz 60 1 yr. Warranty Includes Scalloped Face Rug Tool Bristle Floor Brush Round Dusting Brush Upholstery Tool with Slide on Brush Crevice Tool Paddle Tool and (2) Extension Wands

Item Details

Price: \$386.60
UOM: EA
Qty Per UOM: 1
Contractor: Grainger Ind. Supply
Contract Number: TXMAS-2-539030 (/contracts/view/740)
Contract Type: TXMAS
Commodity Code: 36580
Min. Order Quantity: 1
Delivery Days: 5
NIGP Code: 36580
Item Availability Start Date: 1/1/2015

Item Availability End Date: 4/30/2015

Supplier Part Number: 13P567

Manufacturer Part #: OR1006

Manufacturer: ORECK

UNSPSC: 47121602

Add to cart (</product/2726100?itemdetail>)

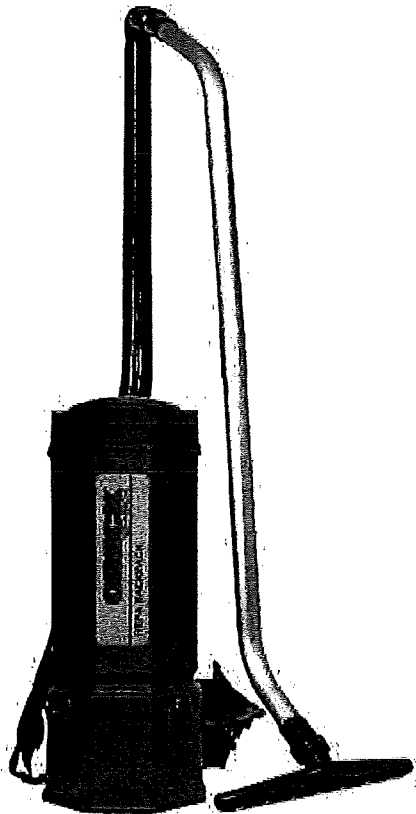

[Texas.gov \(http://www.texas.gov/en/Pages/default.aspx\)](http://www.texas.gov/en/Pages/default.aspx)

[Statewide Search from the Texas State Library \(https://www.tsl.state.tx.us/trail/index.html\)](https://www.tsl.state.tx.us/trail/index.html)

[State Link Policy \(http://www.dir.texas.gov/pubs/pages/weblink-privacy.aspx\)](http://www.dir.texas.gov/pubs/pages/weblink-privacy.aspx)

[Texas Homeland Security \(http://governor.state.tx.us/homeland\)](http://governor.state.tx.us/homeland)

[Texas Transparency \(http://www.texas Transparency.org/\)](http://www.texas Transparency.org/)

[Report Fraud \(http://www.window.state.tx.us/fraud.html\)](http://www.window.state.tx.us/fraud.html)

Glenn Hegar, Texas Comptroller • [Window on State Government \(http://www.window.state.tx.us/\)](http://www.window.state.tx.us/) • [Contact Us \(http://www.window.state.tx.us/contact.html\)](http://www.window.state.tx.us/contact.html)

Privacy and Security Policy (<http://www.window.state.tx.us/privacy.html>)

Accessibility Policy (<http://www.window.state.tx.us/accessibility.html>)

Link Policy (<http://www.window.state.tx.us/linkpolicy.html>)

Public Information Act (<http://www.window.state.tx.us/pia.html>)

Texas Veterans Portal (<http://veterans.portal.texas.gov/en/Pages/default.aspx>)

Compact with Texans (<http://www.window.state.tx.us/comptrol/compact/>)



Glenn Hegar Texas Comptroller of Public Accounts

(http://www.window.state.tx.us/)

Welcome, Roberson, Larry



(/)

Search:

Commodity Code, Supplier Part #, NIGP or Keyword

Contracts Reports Help (/help)



0 items

Back To Search Results

FLOOR MACHINE, 20 1.5 HP

Description: SANITAIRE 20"FLOOR MACHINE, 1.5HP Pad Driver/Holder not included Pad Driver/Holder for this model is item QXY782719

Item Details

Price: \$940.89

UOM: EA

Qty Per UOM: 1

Contractor: American Hotel Register Co.-TXMAS

Contract Number: TXMAS-11-73030 (/contracts/view/497)

Contract Type: TXMAS

Commodity Code: 36510

Min. Order Quantity: 1

Delivery Days: 14

NIGP Code: 36510

Item Availability Start Date: 9/1/2013

Item Availability End Date: 4/30/2015

Supplier Part Number: C7HSC6025

Manufacturer Part #: SC6025A

Manufacturer: Electrolux Home Care Products
Order in Increment Quantity: 1

Add to cart (/product/911063?itemdetail)

[Texas.gov \(http://www.texas.gov/en/Pages/default.aspx\)](http://www.texas.gov/en/Pages/default.aspx)

[Statewide Search from the Texas State Library \(https://www.tsl.state.tx.us/trail/index.html\)](https://www.tsl.state.tx.us/trail/index.html)

[State Link Policy \(http://www.dir.texas.gov/pubs/pages/weblink-privacy.aspx\)](http://www.dir.texas.gov/pubs/pages/weblink-privacy.aspx)

[Texas Homeland Security \(http://governor.state.tx.us/homeland\)](http://governor.state.tx.us/homeland)

[Texas Transparency \(http://www.texasransparency.org/\)](http://www.texasransparency.org/)

[Report Fraud \(http://www.window.state.tx.us/fraud.html\)](http://www.window.state.tx.us/fraud.html)

Glenn Hegar, Texas Comptroller • Window on State Government (http://www.window.state.tx.us/) • Contact Us (http://www.window.state.tx.us/contact.html)

[Privacy and Security Policy \(http://www.window.state.tx.us/privacy.html\)](http://www.window.state.tx.us/privacy.html)

[Accessibility Policy \(http://www.window.state.tx.us/accessibility.html\)](http://www.window.state.tx.us/accessibility.html)

[Link Policy \(http://www.window.state.tx.us/linkpolicy.html\)](http://www.window.state.tx.us/linkpolicy.html)

[Public Information Act \(http://www.window.state.tx.us/pia.html\)](http://www.window.state.tx.us/pia.html)

[Texas Veterans Portal \(http://veterans.portal.texas.gov/en/Pages/default.aspx\)](http://veterans.portal.texas.gov/en/Pages/default.aspx)

[Compact with Texans \(http://www.window.state.tx.us/comptrol/compact/\)](http://www.window.state.tx.us/comptrol/compact/)



Glenn Hegar Texas Comptroller of Public Accounts

(http://www.window.state.tx.us/)

Welcome, Roberson, Larry



(/)

Search:

Commodity Code, Supplier Part #, NIGP or Keyword

Contracts Reports Help (/help)



0 items

Back To Search Results

High Speed Burnisher 1500 RPM

Description: High Speed Burnisher Brush Speed 1500 RPM Motor 1.5 HP DC Rectified Pad Size 20 In. Power Source 115VAC 60 Hz 13.5A Sound Level 68 dBA Construction Metal Cord Length 50 ft. Includes Pad Driver

Item Details

Price: \$884.76
UOM: EA
Qty Per UOM: 1
Contractor: Grainger Ind. Supply
Contract Number: TXMAS-2-539030 (/contracts/view/740)
Contract Type: TXMAS
Commodity Code: 36560
Min. Order Quantity: 1
Delivery Days: 7
NIGP Code: 36560
Item Availability Start Date: 1/1/2015
Item Availability End Date: 4/30/2015
Supplier Part Number: 4NEK5

Manufacturer Part #: 4NEK5
Manufacturer: DAYTON
UNSPSC: 47121603

Add to cart (/product/2758217?itemdetail)

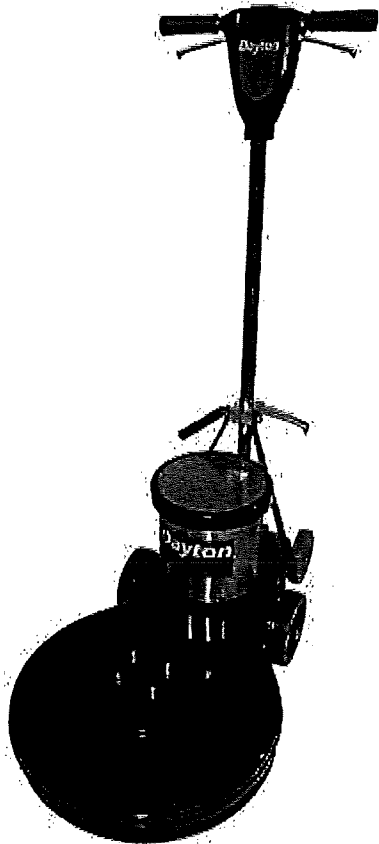

Texas.gov (<http://www.texas.gov/en/Pages/default.aspx>)

Statewide Search from the Texas State Library (<https://www.tsl.state.tx.us/trail/index.html>)

State Link Policy (<http://www.dir.texas.gov/pubs/pages/weblink-privacy.aspx>)

Texas Homeland Security (<http://governor.state.tx.us/homeland>)

Texas Transparency (<http://www.texas Transparency.org/>)

Report Fraud (<http://www.window.state.tx.us/fraud.html>)

Glenn Hegar, Texas Comptroller • Window on State Government (<http://www.window.state.tx.us/>) • Contact Us (<http://www.window.state.tx.us/contact.html>)

Privacy and Security Policy (<http://www.window.state.tx.us/privacy.html>)

Accessibility Policy (<http://www.window.state.tx.us/accessibility.html>)

Link Policy (<http://www.window.state.tx.us/linkpolicy.html>)

Public Information Act (<http://www.window.state.tx.us/pia.html>)

Texas Veterans Portal (<http://veterans.portal.texas.gov/en/Pages/default.aspx>)

Compact with Texans (<http://www.window.state.tx.us/comptrol/compact/>)

2015.01.20.11 Discussion/Action
to approve Budget Amendment #2014-05 Emergency Management / Homeland Security. Caldwell County received a grant from Flint Hills Resources to benefit first responders and emergency management operations. This amendment adjusts the budget to reflect the revenue received and the expenditure of the funds. There is no net increase of expenditures. Cost:\$0
Speaker: Judge Schawe/Larry Roberson. Backup: 1.

CALDWELL COUNTY, TEXAS
 BUDGET AMENDMENT #2014-05
 EMERGENCY MANAGEMENT/HOMELAND SECURITY
 FISCAL YEAR 2014-2015

<u>DESCRIPTION</u>	<u>ACCOUNT #</u>	<u>INCREASE</u>	<u>DECREASE</u>
MACHINERY & EQUIPMENT-GRANT	001-6650-5320	\$ 7,000.00	
CONTINGENCY	001-6510-4860		\$ 7,000.00
CONTINGENCY	001-6510-4860	7,000.00	
GRANT - FLINT HILL RESOURCES	001-3000-0600		<u>7,000.00</u>
TOTALS		<u>\$ 14,000.00</u>	<u>\$ 14,000.00</u>

Caldwell County received a grant from Flint Hills Resources to benefit first responders and emergency management operations. This amendment adjusts the budget to reflect the revenue to received and the expenditure of the funds. There is no net increase of expenditures.

2015.01.20.12 Discussion/Action to approve Budget Amendment #2014-06 Capital Projects-Justice Center. At the December 8th, 2014 meeting, the Commissioner's Court approved the reduction of the contract with Braun & Butler by \$226,302.00. This amendment transfers the savings to the contingency fund to be used for equipment and the maintenance contract with Braun & Butler. Cost:\$0 **Speaker: Judge Schawe/Larry Roberson. Backup: 1.**

CALDWELL COUNTY, TEXAS
 BUDGET AMENDMENT #2014-06
 CAPITAL PROJECTS-JUSTICE CENTER
 FISCAL YEAR 2014-2015

<u>DESCRIPTION</u>	<u>ACCOUNT #</u>	<u>INCREASE</u>	<u>DECREASE</u>
CONTINGENCY	001-6510-4860	\$ 226,302.00	
CONSTRUCTION COSTS - BRAUN & BUTLER	013-6000-5100		<u>\$ 226,302.00</u>
TOTALS		<u>\$ 226,302.00</u>	<u>\$ 226,302.00</u>

At the December 8, 2014 meeting the Commissioner's Court approved the reduction of the contract with Braun & Butler by \$226,302. This amendment transfers the savings to the contingency fund to be used for equipment and the maintenance contract with Braun & Butler.

2015.01.20.13 Discussion/Action to approve Budget Amendment #2014-07 Non Departmental/Maintenance Department. The attached purchases were approved by the Commissioner's Court at the November and December 2014 meetings. The contracted services represents one-third of the total contract amount of \$144,337.00 for a three year maintenance contract with Braun & Butler to support County personnel in maintenance of critical systems with the Justice Center. The balance of \$115,153 is to be returned to reserves. Cost:\$0 **Speaker: Judge Schawe/Larry Roberson. Backup:1.**

CALDWELL COUNTY, TEXAS

BUDGET AMENDMENT #2014-07

NON DEPARTMENTAL/MAINTENANCE DEPARTMENT

FISCAL YEAR 2014-2015

<u>DESCRIPTION</u>	<u>ACCOUNT #</u>	<u>INCREASE</u>	<u>DECREASE</u>
EQUIPMENT - HAND HELD RADIOS	001-6510-5310	\$ 56,037.00	
EQUIPMENT - SCBA UNIT	001-6510-5310	4,500.00	
EQUIPMENT - AED UNIT	001-6510-5310	2,500.00	
CONTRACTED SERVICES	001-6520-4527	48,112.00	
CONTINGENCY	001-6510-4860		\$ 226,302.00
GENERAL FUND RESERVES	001-3010	115,153.00	
TOTALS		<u>\$ 226,302.00</u>	<u>\$ 226,302.00</u>

The above purchases were approved by the Commissioner's Court at the November and December meetings. The Contracted Services represents one-third of the total contract amount of \$144,337 for a 3 year maintenance contract with Braun & Butler to support County personnel in the maintenance of critical systems with the Justice Center. The balance of \$115,153 is to be returned to reserves.

CALDWELL COUNTY, TEXAS
CONTINGENCY FUND BUDGET
FISCAL 2014-2015

				<u>BALANCE</u>
BEGINNING BUDGET - 10/01/2014				\$ 116,624.00
<u>Changes:</u>	<u>Department</u>	<u>Increase</u>	<u>Decrease</u>	
Amendment 2014-01	Veteran's Service		\$ 500.00	116,124.00
Amendment 2014-02	Constable Pct# 3		5,000.00	111,124.00
Amendment 2014-03	Courthouse Security		56,036.50	55,087.50
Amendment 2014-04	Maintenance		6,150.00	48,937.50
Amendment 2014-05	Emergency Management/ Homeland Security	7,000.00	7,000.00	48,937.50
Amendment 2014-06	Capital Projects	226,302.00		275,239.50
Amendment 2014-07	Non Departmental/ Maintenance		226,302.00	48,937.50

2015.01.20.14

Discussion/Action to consider approval of payment for Tracy Bratton, P.E. with Bowman Consulting to address issues concerning adopted subdivision regulations with our Caldwell County Development Ordinance. Cost: Not to exceed \$350.00 for two hours of service. **Speaker: Commissioner Roland/Kasi Miles. Backup:0.**

2015.01.20.15 Discussion/Action
to discuss closure of County Clerk's
Office during the lunch hour of 12:00
noon to 01:00pm. **Speaker:**
Commissioner Moses. Backup:1.

4.07 Work Week

Your working hours depend on the type of job you are doing. Most full-time employees are scheduled to work 40 hours per week. Because of the nature of various department activities, schedules for workdays and lunch periods vary. Your supervisor will explain the schedule for your job. If you are unable to report to work, notify your supervisor as soon as possible, in accordance with the policies of your department.

For payroll purposes, Caldwell County recognizes seven (7) minutes as the minimum time. Increments of time seven (7) minutes or less will not be recognized for payroll purposes. Increments of more than seven (7) minutes will be rounded to the nearest quarter hour and employees will be compensated for the quarter hour. For example: An employee who works for eight hours and five minutes will be paid for eight hours of work. An employee who works for eight hours and eight minutes will be paid for eight hours and fifteen minutes.

Unless specifically requested to work through lunch, the County expects you to take a lunch break. Additional or substitute work hours on weekdays, nights, or weekends may be required. You may be required to come into work on days or at times other than your normal working days or times, at the request of your supervisor or others in the County.

4.08 Rest Periods (Break Time)

Rest periods of fifteen (15) minutes or less are not required by the Fair Labor Standards Act (FLSA) and should not interfere with proper performance of work responsibilities and schedules. If workflow permits and if authorized by their immediate supervisors, employees may take up to two fifteen (15) minute rest periods each work day. If authorized, rest periods do not accumulate if not taken. To the extent possible, rest periods will be provided in the middle of work periods. Since rest periods are counted and paid as time worked, employees must not be absent from their work stations beyond the allocated time. Additionally, employees may be requested to curtail the rest period, if necessary, to provide adequate customer service in high customer service areas.

The FSLA requires a reasonable break for nursing mothers to express breast milk during the first year following the birth of a child. Caldwell County will provide a paid break up to 30 minutes for nursing mothers, the nursing mother will be allowed whatever time is needed to express breast milk, however, if the break is longer than 30 minutes in duration, the break time will be unpaid time off. The mother will be given a private location, not a bathroom to express breast milk. The location will be determined on a case by case basis.

Caldwell County does not allow any retaliation against nursing mothers for asking for this break. Nursing mothers are entitled to this break for one (1) year following the birth of their child.

2015.01.20.16

Discussion/Action concerning the Burn
Ban for Caldwell County. Cost:\$0
Speaker: Judge Schawe/Martin
Ritchey. Backup: 0

2015.01.20.17 Discussion/Action to approve a Public Hearing regarding a petition for creation of Emergency Services District #4 for Mid-County Volunteer Fire Department and to set a public hearing date. Cost:TBD.
Speaker: Judge Schawe/Martin Ritchey. Backup:1

PETITION FOR THE CREATION OF CALDWELL COUNTY EMERGENCY SERVICES DISTRICT NO. 4

Pursuant to Texas Health and Safety Code, Chapter 775, the undersigned petitioners hereby petition for the creation of an emergency services district whose territorial boundaries would be those as further described in the attached Exhibit A, attached hereto and incorporated herein for all purposes. The proposed Caldwell County Emergency Services District No. 4 is to be created and is to operate under Article III, Section 48-e, Texas Constitution, and Chapter 775, Texas Health & Safety Code, and may provide some or all of the emergency services set forth in Article III, Section 48-e, Texas Constitution. The creation of the proposed Caldwell County Emergency Services District No.4 complies with Sections 775.020 and 775.0205, Health and Safety Code.

The following are municipalities from which consent must be obtained under Section 775.014: City of Lockhart and the City of Luling.

The undersigned two petitioners obligate themselves to pay not more than \$150 of the costs incident to the formation of the proposed district, including the costs of publishing notices, election costs, and other necessary and incidental expenses.

OBLIGOR NO. 1

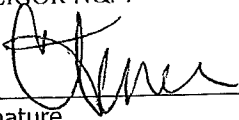

Signature

Charlene Tiner

Printed Name

510 Brownsboro Lane

Mailing Address

Lockhart Tx 78644

City, State, Zip Code

Same

Residence Address

10-6-1970

Date of Birth

9-5-2014

Date of Signing

OBLIGOR NO. 2



Signature

Edward Hanna

Printed Name

1077 Burdette Wells Rd.

Mailing Address

Lockhart, Tx 78644

City, State, Zip Code

1077 Burdette Wells Rd

Residence Address

25 Nov 1978 / 5 Sept 2014

Date of Birth

Date of Signing

1003954524

Voter Registration No.

1068849605

Voter Registration No.

SWORN TO AND SUBSCRIBED before me, the undersigned authority, by Charlene Tiner, as Obligor No. 1, on this the 5th day of September 2014.

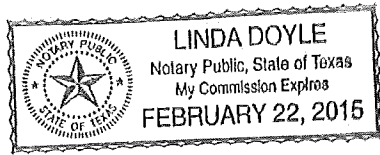

Linda Doyle
NOTARY PUBLIC IN AND FOR THE
STATE OF TEXAS

SWORN TO AND SUBSCRIBED before me, the undersigned authority, by Edward Hanna, as Obligor No. 2, on this the 5th day of September 2014.

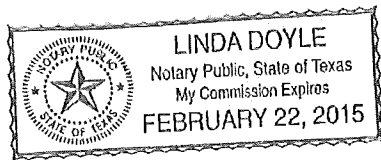

Linda Doyle
NOTARY PUBLIC IN AND FOR THE
STATE OF TEXAS

Being approximately 50.36 square miles of land in Caldwell County, Texas, described below in 2 tracts, consisting of the major portion of the Mid-County Volunteer Fire Department (VFD), to comprise the Caldwell County Emergency Services District No. 1.

TRACT No 1. Being 0.34 square miles of land and being those tracts of land which are excluded, by virtue of development agreements, which are filed with the City Secretary of the City of Lockhart, Caldwell County, Texas and are identified in the Annexation Ordinance of the City of Lockhart 07-26, dated 8Aug07, said Ordinance being of record in Book 504, at Page 519, Official Records of Caldwell County.

TRACT No 2. Being 50.02 square miles of land in Caldwell County, wit:

BEGINNING at the intersection centerline of Lay Road (also known as County Road 206) with the west line of FM 1322 (also known as Commerce St) and a south line of Corporate Limits of the City of Lockhart.

THENCE easterly, with said centerline, to a bend to the southeast being a corner in said Corporate Limits and a northwest corner of the McMahan VFD.

THENCE with said centerline and a west line of the McMahan VFD to the southeast, there being a short westerly jog at Young Lane (also known as Cty Rd 197), being also the southwest corner of the McMahan VFD and the NW corner of the Southeast VFD, continuing with the centerline of Seawillow Rd and a westerly line of the Southeast VFD to its intersection with the centerline of Clear Fork Rd (also known as Cty Rd 194) a southwest corner of the Southeast VFD and an interior corner off this tract.

THENCE with the centerline of Clear Ford Road and the west line of the Southeast VFD, to its intersection with the centerline of FM 86 for an easterly corner of this tract.

THENCE southwesterly with the centerline of FM 86, passing the centerline of Clearfork Road to the south, this being a corner in the west line of the Southeast VFD and the most northerly corner of the Luling VFD, to the centerline of Oak Grove Road (also known as Cty Rd 127) for the southeast corner of this tract.

Thence generally westerly with the centerline of Oak Grove Road, and the northerly line of the Luling VFD, to its intersection with the centerline of Highway 183.

THENCE directly, with said north line to the southwest, crossing US Hwy 183, to the intersection of the centerline intersection of FM 2984 and of Union Hill Road (also known as Cty Rd 123).

THENCE with the centerline of Union Hill Road and of said north line, to its intersection with the Washburn Road (also known as Cty Rd 115) for an interior corner of the Luling VFD and the most southerly corner of this.

THENCE northwesterly with the centerline of the Washburn Road, crossing the centerline of FM 671, being the most easterly corner of the Tri-Community VFD and the most northerly corner of the Luling VFD. continuing now with the centerline of Bugtussle Lane (also known as Cty Rd 115), to its intersection with the centerline of Acorn Road (also known as Cty Rd 126) and with said centerline to its intersection with FM 20 (also known as Park Road).

THENCE northeasterly, with the centerline of FM 20W, being the southeast line of the Tri-community VFD and then of the Maxwell VFD, to a southwest line of the Corporate Limits of the City of Lockhart for the northwest corner of the Mid-County VFD and of this.

THENCE in generally alternating southeasterly and northeasterly directions, with south line of said Corporate Limits and a north line of the Mid-County VFD and of this tract, to the centerline of US Hwy 183 (also known as South Colorado).

THENCE southerly, with said centerline, to the most southerly corner of said Corporate Limits and being an interior corner of the Mid-County VFD and of this tract.

THENCE northeasterly, with said common line, to the west line of FM 1322, a southeast corner of said Corporate Limits and an interior corner of the Mid-County VFD and of this tract.

THENCE northwesterly with said common line, being the west line of FM 1322, to the point of beginning.

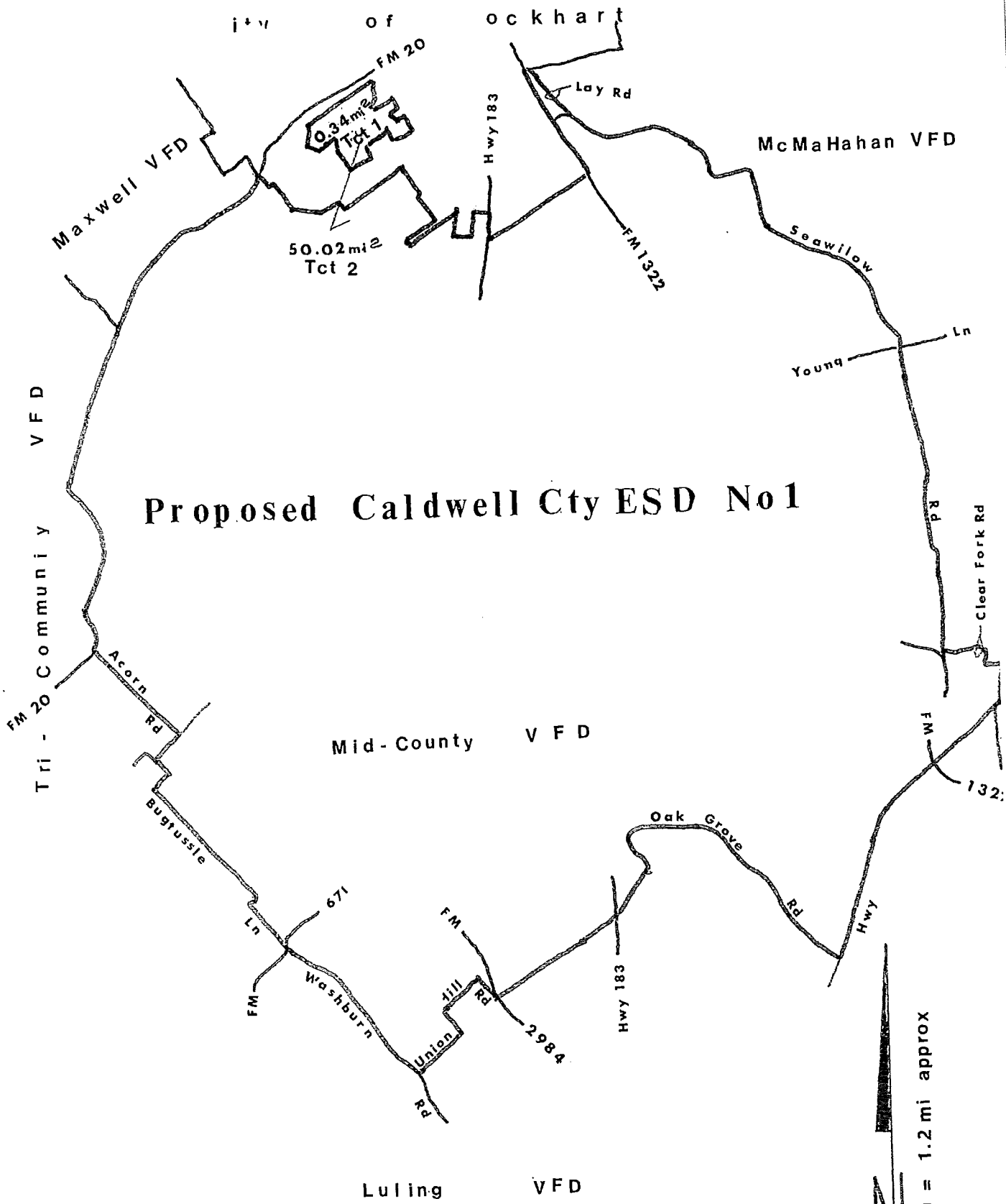

1 in = 1.2 mi approx

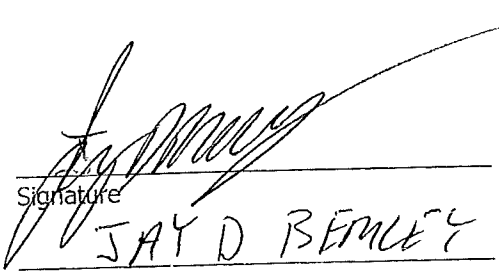
Signature

JAY D BENTLEY
Printed Name

1665 FM 671
Mailing Address

LOCKHART TX 78644
City, State, Zip Code

SAME
Residence Address

6-19-63 1-11-14
Date of Birth Date of Signing

IN MAIL
Voter Registration No.

Phone Number 313-610-0547

Signature

Printed Name

Mailing Address

City, State, Zip Code

Residence Address

Date of Birth Date of Signing

Voter Registration No.

Phone Number

Signature

Printed Name

Mailing Address

City, State, Zip Code

Residence Address

Date of Birth Date of Signing

Voter Registration No.

Phone Number

Signature

Printed Name

Mailing Address

City, State, Zip Code

Residence Address

Date of Birth Date of Signing

Voter Registration No.

Phone Number

Richard Wallsmith

Signature

Richard Wallsmith

Printed Name

3041 FM 671

Mailing Address

Luling, TX 78648

City, State, Zip Code

Same

Residence Address

3/11/40

Date of Birth

9/20/14

Date of Signing

1003982685

Voter Registration No.

Phone Number 830-357-0562

Signature

Printed Name

Mailing Address

City, State, Zip Code

Residence Address

Date of Birth

Date of Signing

Voter Registration No.

Phone Number

Sherry Wallsmith

Signature

Sherry Wallsmith

Printed Name

3041 FM 671

Mailing Address

Luling, TX 78648

City, State, Zip Code

3041 FM 671

Residence Address

10/20/49

Date of Birth

9/20/2014

Date of Signing

1003982663

Voter Registration No.

Phone Number 830-357-1002

Signature

Printed Name

Mailing Address

City, State, Zip Code

Residence Address

Date of Birth

Date of Signing

Voter Registration No.

Phone Number

Tate S. Simmons
Signature

Tate S. Simmons
Printed Name

1193 Brushy Branch Rd.
Mailing Address

Lockhart TX 78644
City, State, Zip Code

1193 Brushy Branch Rd.
Residence Address

12/1/1950 1/10/15
Date of Birth Date of Signing

1003998894
Voter Registration No.

512-995-0529
Phone Number

Signature

Printed Name

Mailing Address

City, State, Zip Code

Residence Address

Date of Birth Date of Signing

Voter Registration No.

Phone Number

Signature

Printed Name

Mailing Address

City, State, Zip Code

Residence Address

Date of Birth Date of Signing

Voter Registration No.

Phone Number

Signature

Printed Name

Mailing Address

City, State, Zip Code

Residence Address

Date of Birth Date of Signing

Voter Registration No.

Phone Number

Donald E. Chesser
Signature

DONALD E. CHESSEER
Printed Name

360 BRUSHY BRANCH ROAD
Mailing Address

LOCKHART, TX 78644
City, State, Zip Code

360 BRUSHY BRANCH ROAD
Residence Address

08-23-1942 12-21-2014
Date of Birth Date of Signing

1004040916
Voter Registration No.

CELL 830-857-5710
Phone Number 512-398-3849

Melvin Rogas Sr.
Signature

MELVIN ROGAS SR
Printed Name

1180 YOUNG LANE
Mailing Address

LOCKHART TEXAS
City, State, Zip Code

1180 YOUNG LANE
Residence Address

7/14/1935 12/21/2014
Date of Birth Date of Signing

1003999000
Voter Registration No.

Phone Number (512) 398-3147 cell# (512) 376-1639

Michael Shane Mondin
Signature

Michael Shane Mondin
Printed Name

3430 Seawillow Rd
Mailing Address

Lockhart, TX 78644
City, State, Zip Code

3430 Seawillow Rd
Residence Address

8-11-1967 12-24-14
Date of Birth Date of Signing

1003954548
Voter Registration No.

512-398-9862
Phone Number

MARYLOW ROGAS
Signature

Marylow Rogas
Printed Name

1180 Young Ln.
Mailing Address

Lockhart, TX 78644
City, State, Zip Code

1180 Young Ln.
Residence Address

11/15/27 12/21/14
Date of Birth Date of Signing

1004021953
Voter Registration No.

512-227-6181
Phone Number

Jennie L. Pfeil
Signature

Signature

Jennie L. Pfeil

Printed Name

32 Harris

Mailing Address

Lockhart Texas 78644

City, State, Zip Code

Residence Address

09-05-1940 01-11-2015
Date of Birth Date of Signing

1003990541

Voter Registration No.

Phone Number

Tom A. Efird
Signature

Signature

TOM A. EFIRD

Printed Name

6582 SEAWILLOW Rd.

Mailing Address

LOCKHART, TX 78644

City, State, Zip Code

Residence Address

06.09.194 01.11.15
Date of Birth Date of Signing

1003990539

Voter Registration No.

512.398.7477

Phone Number

Signature

Printed Name

Mailing Address

City, State, Zip Code

Residence Address

Date of Birth Date of Signing

Voter Registration No.

Phone Number

Geneva J. Efird
Signature

Signature

GENEVA J. EFIRD

Printed Name

6582 Seawillow Rd

Mailing Address

LOCKHART, TX 78644

City, State, Zip Code

same

Residence Address

9-21-45 01-11-2015
Date of Birth Date of Signing

1003954569

Voter Registration No.

512 398-7477

Phone Number

R Holden
Signature
Robert Holden
Printed Name
375 Kinsey Trl
Mailing Address
Luling, Tx 78648
City, State, Zip Code

same
Residence Address
8/30/72 1/4/15
Date of Birth Date of Signing
1015575537
Voter Registration No.

Phone Number

Frankie Robinson
Signature
Frankie Robinson
Printed Name
310 Paintbrush Trail
Mailing Address
Lockhart TX 78644
City, State, Zip Code

same
Residence Address
2/14/48 1/4/15
Date of Birth Date of Signing
1004038350
Voter Registration No.

Phone Number

Marcella Strahan
Signature
Marcella STRAHAN
Printed Name
1216 Brushy Branch Rd
Mailing Address
Lockhart TX 78644
City, State, Zip Code

Residence Address
2-17-51 1-4-15
Date of Birth Date of Signing
1175379755
Voter Registration No.

512-517-2044
Phone Number

Signature
Printed Name
Mailing Address
City, State, Zip Code

Residence Address
Date of Birth Date of Signing
Voter Registration No.

Phone Number

[Signature]
Signature
JOSEPH Colacello
Printed Name
194 MINERAL SPRINGS RD
Mailing Address
Lockhart Tx 78644
City, State, Zip Code

SAME
Residence Address
10/4/66 9/6/14
Date of Birth Date of Signing
1159 258536
Voter Registration No.

[Signature]
Signature
THOMAS C. HARTINS
Printed Name
373 T. M. 671
Mailing Address
Lockhart, TX 78644
City, State, Zip Code

SAME
Residence Address
08/25/1963 9.6-14
Date of Birth Date of Signing
1140562109
Voter Registration No.
512-363-3282
Phone Number

[Signature]
Signature
Kimberly Whlig
Printed Name
372 Brownsboro Ln.
Mailing Address
Lockhart Tx 78644
City, State, Zip Code

[Signature]
Residence Address
07/29/65 9/6/14
Date of Birth Date of Signing
1010897728
Voter Registration No.

[Signature]
Signature
RAY NASH
Printed Name
474 SEAVILLAW ROAD
Mailing Address
Lockhart, TX 78644
City, State, Zip Code

SAME AS MAILING
Residence Address
10/17/50 9/6/2014
Date of Birth Date of Signing
1003998319
Voter Registration No.
512-398-6450
Phone Number

Richard Tidwell
Signature

RICHARD TIDWELL
Printed Name

9060 F.M. 1322
Mailing Address

LOCKHART TX 78644
City, State, Zip Code

Residence Address

6-21-46 9-6-14
Date of Birth Date of Signing

1151952581
Voter Registration No.

Phone Number

Signature

Printed Name

Mailing Address

City, State, Zip Code

Residence Address

Date of Birth Date of Signing

Voter Registration No.

Phone Number

Signature

Printed Name

Mailing Address

City, State, Zip Code

Residence Address

Date of Birth Date of Signing

Voter Registration No.

Phone Number

Signature

Printed Name

Mailing Address

City, State, Zip Code

Residence Address

Date of Birth Date of Signing

Voter Registration No.

Phone Number

Donald Graham

Signature

Donald GRAHAM

Printed Name

905 GRAHAM Rd

Mailing Address

Lockhart TX 78644

City, State, Zip Code

Residence Address

9-24-44 9-24-44

Date of Birth

Date of Signing

1003987872

Voter Registration No.

Phone Number 512-398-2062

Frances C Graham

Signature

Frances L. Graham

Printed Name

905 Graham Rd,

Mailing Address

Lockhart, TX 78644

City, State, Zip Code

905 Graham Rd.

Residence Address

7/8/40 9/23/14

Date of Birth

Date of Signing

1003987864

Voter Registration No.

Phone Number 512-398-2062

Joel Graham

Signature

Joel GRAHAM

Printed Name

1014 GRAHAM ROAD

Mailing Address

Lockhart TX 78644

City, State, Zip Code

SAME

Residence Address

1-4-71 10-18-2014

Date of Birth

Date of Signing

1172579456

Voter Registration No.

512-398-7139

Phone Number

Ether Graham

Signature

Ether GRAHAM

Printed Name

1014 GRAHAM ROAD

Mailing Address

Lockhart TX 78644

City, State, Zip Code

SAME

Residence Address

9-11-71 10-18-2014

Date of Birth

Date of Signing

1010888646

Voter Registration No.

512-398-7139

Phone Number

Candy Busch
Signature

Candy Busch
Printed Name

809 Burdette Wells
Mailing Address

Lockhart, TX
City, State, Zip Code

78644
Residence Address

Same
Residence Address

4-30-59 1/12/15
Date of Birth Date of Signing

1198130603
Voter Registration No.

512-738-1600
Phone Number

Signature

Printed Name

Mailing Address

City, State, Zip Code

Residence Address

Date of Birth Date of Signing

Voter Registration No.

Phone Number

Laurie Hanna
Signature

Laurie Hanna
Printed Name

1077 Burdette Wells
Mailing Address

Lockhart, TX 78644
City, State, Zip Code

Same
Residence Address

1/25/73 1/12/15
Date of Birth Date of Signing

1158015795
Voter Registration No.

512-745-1103
Phone Number

Edward Hanna
Signature

Edward Hanna
Printed Name

1077 Burdette Wells Rd
Mailing Address

Lockhart, TX 78644
City, State, Zip Code

Same
Residence Address

11-25-1978 1/12/15
Date of Birth Date of Signing

1068849605
Voter Registration No.

512-619-1173
Phone Number

Judy E. Cathey
Signature

JUDY ECATHEY
Printed Name

96 SIERRA DRIVE
Mailing Address

LOCKHART, TX 78644
City, State, Zip Code

96 SIERRA DRIVE
Residence Address

3/24/1959 12/1/2014
Date of Birth Date of Signing

1004029443
Voter Registration No.

512-738-2255
Phone Number

Fred Cathey
Signature

FRED CATHEY
Printed Name

96 SIERRA DRIVE
Mailing Address

LOCKHART, TX 78644
City, State, Zip Code

96 SIERRA DRIVE
Residence Address

7/27/1942 12/1/2014
Date of Birth Date of Signing

1004017392
Voter Registration No.

512-995-0986
Phone Number

Signature

Printed Name

Mailing Address

City, State, Zip Code

Residence Address

Date of Birth Date of Signing

Voter Registration No.

Phone Number

Signature

Printed Name

Mailing Address

City, State, Zip Code

Residence Address

Date of Birth Date of Signing

Voter Registration No.

Phone Number

Greg Pope
Signature
Gregory Pope
Printed Name
162 Paintbrush Tr.
Mailing Address
Lockhart TX 78644
City, State, Zip Code
162 Paintbrush Tr.
Residence Address
02-11-71 10-30-14
Date of Birth Date of Signing
1017223150
Voter Registration No.
512-626-0173
Phone Number

Faith Pope
Signature
Faith Pope
Printed Name
162 Paintbrush Tr.
Mailing Address
Lockhart TX, 78644
City, State, Zip Code
Same as above
Residence Address
11-15-1970 10-30-14
Date of Birth Date of Signing
1013820314
Voter Registration No.
(512) 626-1497
Phone Number

Carol M. Olson
Signature
Carol M. Olson
Printed Name
162 Paintbrush Tr.
Mailing Address
Lockhart, Tx 78644
City, State, Zip Code
162 Paintbrush Tr.
Residence Address
4-23-40 11-20-14
Date of Birth Date of Signing
1022147573
Voter Registration No.
512-644-8659
Phone Number

Signature

Printed Name

Mailing Address

City, State, Zip Code

Residence Address

Date of Birth Date of Signing

Voter Registration No.

Phone Number

JAVIER MORALES
Signature

JAVIER MORALES
Printed Name

P.O. Box 381
Mailing Address

Luling, TX 78648
City, State, Zip Code

1748 Fm 2984
Residence Address

10-1-68 11-19-14
Date of Birth Date of Signing

1022740201
Voter Registration No.

830-203-9090
Phone Number

J. Mark Huckabee
Signature

J. MARK HUCKABEE
Printed Name

10545 S. Hwy 183
Mailing Address

LOCKHART, TX 78644
City, State, Zip Code

AS ABOVE
Residence Address

6-4-54 11-19-14
Date of Birth Date of Signing

1004938220
Voter Registration No.

830 875-6305
Phone Number

Tina Morales
Signature

Tina Morales
Printed Name

P.O. Box 381
Mailing Address

Luling, TX 78648
City, State, Zip Code

1748 Fm 2984
Residence Address

5-22-70 11-19-14
Date of Birth Date of Signing

1004306001
Voter Registration No.

830 203-9477
Phone Number

Eileen Huckabee
Signature

Eileen Huckabee
Printed Name

10545 S. HWY 183
Mailing Address

Lockhart, TX 78644
City, State, Zip Code

same
Residence Address

6/28/57 11/19/14
Date of Birth Date of Signing

1004938208
Voter Registration No.

830-875-6305 (office)
Phone Number

Marie Graham
Signature

Marie Graham
Printed Name

1205 Graham Rd.
Mailing Address

Lockhart, TX. 78644
City, State, Zip Code

Same
Residence Address

10-23-1978 01-11-15
Date of Birth Date of Signing

1158384710
Voter Registration No.

Phone Number 512-284-0677

Daniel Graham
Signature

Daniel Graham
Printed Name

1205 Graham Rd.
Mailing Address

Lockhart, TX. 78644
City, State, Zip Code

Same
Residence Address

07-17-1972 01-11-15
Date of Birth Date of Signing

1015378185
Voter Registration No.

Phone Number 512-284-0678

Signature

Printed Name

Mailing Address

City, State, Zip Code

Residence Address

Date of Birth Date of Signing

Voter Registration No.

Phone Number

Signature

Printed Name

Mailing Address

City, State, Zip Code

Residence Address

Date of Birth Date of Signing

Voter Registration No.

Phone Number

Sheri Lindler
Signature (For Volunteer FD)

Sheri Lindler
Printed Name

9765 State Park Rd.
Mailing Address

Lockhart, TX 78644
City, State, Zip Code

10315 77303
Residence Address

8/9/62 1-11-15
Date of Birth Date of Signing

Voter Registration No.

512/227-5007
Phone Number

Signature

Printed Name

Mailing Address

City, State, Zip Code

Residence Address

Date of Birth Date of Signing

Voter Registration No.

Phone Number

Signature

Printed Name

Mailing Address

City, State, Zip Code

Residence Address

Date of Birth Date of Signing

Voter Registration No.

Phone Number

Signature

Printed Name

Mailing Address

City, State, Zip Code

Residence Address

Date of Birth Date of Signing

Voter Registration No.

Phone Number

[Signature]
Signature

Dora R Fogle
Printed Name

3656 Westwood Rd
Mailing Address

Lockhart, Tx 78644
City, State, Zip Code

3656 Westwood Rd
Residence Address

09-05-1967 1.11.15
Date of Birth Date of Signing

Tx DL 13678307
Voter Registration No.

Phone Number 512 995-0173

[Signature]
Signature

Steven Fogle
Printed Name

3656 Westwood Rd
Mailing Address

Lockhart TX 78644
City, State, Zip Code

Same
Residence Address

Feb 17 1965 Jan 11 2015
Date of Birth Date of Signing

1141922495
Voter Registration No.

Phone Number 512-376-9040

Signature

Printed Name

Mailing Address

City, State, Zip Code

Residence Address

Date of Birth Date of Signing

Voter Registration No.

Phone Number

Signature

Printed Name

Mailing Address

City, State, Zip Code

Residence Address

Date of Birth Date of Signing

Voter Registration No.

Phone Number

DEA
Signature

Danny ZEA
Printed Name

590 Westwood Rd
Mailing Address

Lockhart TX 78644
City, State, Zip Code

same
Residence Address

8-5-52 12-21-14
Date of Birth Date of Signing

1003975796
Voter Registration No.

398-2210
Phone Number

Signature

Printed Name

Mailing Address

City, State, Zip Code

Residence Address

Date of Birth Date of Signing

Voter Registration No.

Phone Number

Signature

Printed Name

Mailing Address

City, State, Zip Code

Residence Address

Date of Birth Date of Signing

Voter Registration No.

Phone Number

Signature

Printed Name

Mailing Address

City, State, Zip Code

Residence Address

Date of Birth Date of Signing

Voter Registration No.

Phone Number

Allen R. Hellums
Signature
Allen R. Hellums
Printed Name
827 Fm 671
Mailing Address
Lockhart, TX. 78644
City, State, Zip Code
Same
Residence Address
11-24-69 1-3-15
Date of Birth Date of Signing
1162204242
Voter Registration No.
Phone Number 830-305-0861

Jennifer M. Hellums (Henderson)
Signature
Jennifer M. Hellums (Henderson)
Printed Name
827 Fm 671
Mailing Address
Lockhart, TX. 78644
City, State, Zip Code
Same
Residence Address
1-10-74 1-3-15
Date of Birth Date of Signing
1003998422
Voter Registration No.
Phone Number 512-227-6021

Signature

Printed Name

Mailing Address

City, State, Zip Code

Residence Address

Date of Birth Date of Signing

Voter Registration No.

Phone Number

Signature

Printed Name

Mailing Address

City, State, Zip Code

Residence Address

Date of Birth Date of Signing

Voter Registration No.

Phone Number

Carrie
Signature

Carrie Staton
Printed Name

379 Catfish Ln
Mailing Address

Lockhart TX 78044
City, State, Zip Code

379 Catfish Ln
Residence Address

9-11-78 12-28-14
Date of Birth Date of Signing

1179943458
Voter Registration No.

512-738-0801
Phone Number

Signature

Printed Name

Mailing Address

City, State, Zip Code

Residence Address

Date of Birth Date of Signing

Voter Registration No.

Phone Number

Calvin Hensley
Signature

Calvin Hensley
Printed Name

41 S. Lane
Mailing Address

Lockhart Texas
City, State, Zip Code

Same
Residence Address

07-06-62 12-28-14
Date of Birth Date of Signing

1007634021
Voter Registration No.

512-787-7667
Phone Number

Connie Hensley
Signature

Connie Hensley
Printed Name

41 S. Lane
Mailing Address

Lockhart Texas
City, State, Zip Code

Same
Residence Address

12-24-63 12/28/14
Date of Birth Date of Signing

1020622021
Voter Registration No.

512-995-11665
Phone Number

Thural A Henderson

Signature

Thural A Henderson Perry

Printed Name

69 Stagecoach Ct.

Mailing Address

Lockhart, Tx. 78644

City, State, Zip Code

SAA

Residence Address

08-31-44

Date of Birth

12-04-14

Date of Signing

1004021723

Voter Registration No.

Phone Number 512 376 7559

Robert Henderson

Signature

Robert Henderson

Printed Name

50 Stagecoach Ct.

Mailing Address

Lockhart Tx 78644

City, State, Zip Code

50 Stagecoach Ct.

Residence Address

08-05-1950

Date of Birth

12-02-14

Date of Signing

1171261573

Voter Registration No.

512-227-6909

Phone Number

James D. Henderson

Signature

James D. Henderson

Printed Name

69 Stagecoach CT.

Mailing Address

Lockhart, Tx. 78644

City, State, Zip Code

SAA

Residence Address

04-18-45

Date of Birth

12-04-14

Date of Signing

1004021734

Voter Registration No.

Phone Number 512 748-8826

Signature

Printed Name

Mailing Address

City, State, Zip Code

Residence Address

Date of Birth

Date of Signing

Voter Registration No.

Phone Number

Signature

Signature

Printed Name

Printed Name

Mailing Address

Mailing Address

City, State, Zip Code

City, State, Zip Code

Residence Address

Residence Address

Date of Birth

Date of Signing

Date of Birth

Date of Signing

Voter Registration No.

Voter Registration No.

Phone Number

Phone Number

Earline Sneed
Signature

Kenneth L. Sneed
Signature

Earline Sneed
Printed Name

Kenneth L. Sneed
Printed Name

1145 Westwood Rd.
Mailing Address

1145 WESTWOOD RD
Mailing Address

Lockhart, Tx 78644
City, State, Zip Code

Lockhart Tx 78644
City, State, Zip Code

1145 Westwood Rd
Residence Address

1145 WESTWOOD RD
Residence Address

9.20.48 12.7.2014
Date of Birth Date of Signing

12/2-48 12/7/48
Date of Birth Date of Signing

1003952872
Voter Registration No.

1003952758
Voter Registration No.

512.376.1475
Phone Number

512 376 1875
Phone Number

Joe Hunter
Signature

Joe Hunter
Printed Name

1573 FM 671
Mailing Address

Lockhart TX 78644
City, State, Zip Code

1573 FM 671
Residence Address

10-21-58 12-20-14
Date of Birth Date of Signing

1011673374
Voter Registration No.

Phone Number 8303510474

Cynthia Hunter
Signature

Cynthia Hunter
Printed Name

1573 F.M. 671
Mailing Address

LOCKHART TX 78644
City, State, Zip Code

1573 F.M. 671
Residence Address

01-20-61 / 12-20-14
Date of Birth Date of Signing

1004050316
Voter Registration No.

Phone Number 8303510434

Signature

Printed Name

Mailing Address

City, State, Zip Code

Residence Address

Date of Birth Date of Signing

Voter Registration No.

Phone Number

Signature

Printed Name

Mailing Address

City, State, Zip Code

Residence Address

Date of Birth Date of Signing

Voter Registration No.

Phone Number

[Signature]
Signature

JOHN CYRER
Printed Name

1301 WESTWOOD RD
Mailing Address

LOCKHART, TX 78644
City, State, Zip Code

SAME ABOVE
Residence Address

5/4/73 12/20/14
Date of Birth Date of Signing

1014517890
Voter Registration No.

(512) 585-1359
Phone Number

[Signature]
Signature

RACHELLE CYRIK Hollister
Printed Name

← SAME
Mailing Address

City, State, Zip Code

Residence Address

2/6/77 12/20/14
Date of Birth Date of Signing

1151750928
Voter Registration No.

(512) 557-2881
Phone Number

Signature

Printed Name

Mailing Address

City, State, Zip Code

Residence Address

Date of Birth Date of Signing

Voter Registration No.

Phone Number

Signature

Printed Name

Mailing Address

City, State, Zip Code

Residence Address

Date of Birth Date of Signing

Voter Registration No.

Phone Number

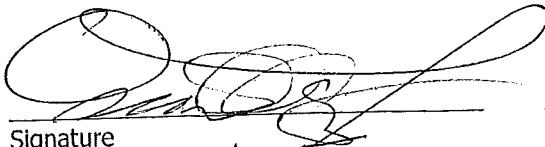

Signature

OSCAR H. FOGLE

Printed Name

3146 WESTWOOD RD

Mailing Address

LOCKHART, TX 78644

City, State, Zip Code

SAME

Residence Address

06/07/40 12/20/14

Date of Birth

Date of Signing

1007024954

Voter Registration No.

512-376-8428

Phone Number 512-376-9950

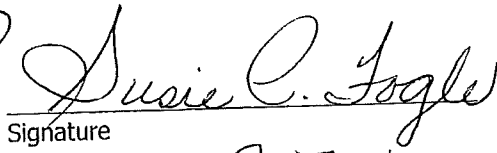

Signature

Susie P. Fogle

Printed Name

3146 Westwood Rd.

Mailing Address

Lockhart, TX 78644

City, State, Zip Code

SAME

Residence Address

10/11/46 12/20/14

Date of Birth

Date of Signing

1008524993

Voter Registration No.

Phone Number 512-376-9950

Signature

Printed Name

Mailing Address

City, State, Zip Code

Residence Address

Date of Birth

Date of Signing

Voter Registration No.

Phone Number

Signature

Printed Name

Mailing Address

City, State, Zip Code

Residence Address

Date of Birth

Date of Signing

Voter Registration No.

Phone Number

[Signature]
Signature

Denver J. Lemons
Printed Name

1303 Westwood Rd
Mailing Address

Lockhart TX 78644
City, State, Zip Code

1303 Westwood Rd
Residence Address

01-18-1964 12-27-2014
Date of Birth Date of Signing

1012261525
Voter Registration No.

512-757-2342
Phone Number

Signature

Printed Name

Mailing Address

City, State, Zip Code

Residence Address

Date of Birth Date of Signing

Voter Registration No.

Phone Number

Signature

Printed Name

Mailing Address

City, State, Zip Code

Residence Address

Date of Birth Date of Signing

Voter Registration No.

Phone Number

Signature

Printed Name

Mailing Address

City, State, Zip Code

Residence Address

Date of Birth Date of Signing

Voter Registration No.

Phone Number

Richard Moya

Signature

Richard Moya

Printed Name

2286 Westwood Rd

Mailing Address

Los Alamos, TX. 78444

City, State, Zip Code

2286 Westwood Rd

Residence Address

1/18/42 11/03/15

Date of Birth

Date of Signing

1004034221

Voter Registration No.

Phone Number 512-326-1355

Signature

Printed Name

Mailing Address

City, State, Zip Code

Residence Address

Date of Birth

Date of Signing

Voter Registration No.

Phone Number

Signature

Printed Name

Mailing Address

City, State, Zip Code

Residence Address

Date of Birth

Date of Signing

Voter Registration No.

Phone Number

Signature

Printed Name

Mailing Address

City, State, Zip Code

Residence Address

Date of Birth

Date of Signing

Voter Registration No.

Phone Number

Arnie Idrogo
Signature

Arnie Idrogo
Printed Name

753 Westwood Road
Mailing Address

Lockhart, Texas 78644
City, State, Zip Code

753 Westwood Rd.
Residence Address

10/03/49 01-03-15
Date of Birth Date of Signing

1006267989
Voter Registration No.

Phone Number (512) 784-5714

Carmen M. Idrogo
Signature

Carmen M. Idrogo
Printed Name

753 Westwood Road
Mailing Address

Lockhart, Texas 78644
City, State, Zip Code

753 Westwood Road
Residence Address

09/11/51 01-03-15
Date of Birth Date of Signing

100397752
Voter Registration No.

Phone Number (512) 784-5714

Carmen M. Idrogo
Signature

Carmen M. Idrogo
Printed Name

753 Westwood Rd
Mailing Address

Lockhart TX 78644
City, State, Zip Code

7
Residence Address

4-22-83 1-3-15
Date of Birth Date of Signing

1018520599
Voter Registration No.

(512) 910-9069
Phone Number

Signature

Printed Name

Mailing Address

City, State, Zip Code

Residence Address

Date of Birth Date of Signing

Voter Registration No.

Phone Number

Janet Barkmeyer
Signature

Janet Barkmeyer
Printed Name

61 Acorn Rd
Mailing Address

Lockhart, TX 78644
City, State, Zip Code

same
Residence Address

4-27-57 1-10-15
Date of Birth Date of Signing

1010961997
Voter Registration No.

512/227-0253
Phone Number

Signature

Printed Name

Mailing Address

City, State, Zip Code

Residence Address

Date of Birth Date of Signing

Voter Registration No.

Phone Number

Signature

Printed Name

Mailing Address

City, State, Zip Code

Residence Address

Date of Birth Date of Signing

Voter Registration No.

Phone Number

Signature

Printed Name

Mailing Address

City, State, Zip Code

Residence Address

Date of Birth Date of Signing

Voter Registration No.

Phone Number

Dosh
Signature

Dustin Little
Printed Name

983 Acorn
Mailing Address

Lockhart TX
City, State, Zip Code

Residence Address

0223-87 1-10-15
Date of Birth Date of Signing

1098752492
Voter Registration No.

Phone Number 832-3098309

Signature

Printed Name

Mailing Address

City, State, Zip Code

Residence Address

Date of Birth Date of Signing

Voter Registration No.

Phone Number

Signature

Printed Name

Mailing Address

City, State, Zip Code

Residence Address

Date of Birth Date of Signing

Voter Registration No.

Phone Number

Signature

Printed Name

Mailing Address

City, State, Zip Code

Residence Address

Date of Birth Date of Signing

Voter Registration No.

Phone Number

Sherril Gibson

Signature

Sherril Gibson

Printed Name

2085 Oak Grove Rd.

Mailing Address

Wuling, TX 78648

City, State, Zip Code

Residence Address

7-2-68 1-10-15

Date of Birth

Date of Signing

11766 1176770529

Voter Registration No.

875-5900

Phone Number

Signature

Printed Name

Mailing Address

City, State, Zip Code

Residence Address

Date of Birth

Date of Signing

Voter Registration No.

Phone Number

Signature

Printed Name

Mailing Address

City, State, Zip Code

Residence Address

Date of Birth

Date of Signing

Voter Registration No.

Phone Number

Signature

Printed Name

Mailing Address

City, State, Zip Code

Residence Address

Date of Birth

Date of Signing

Voter Registration No.

Phone Number

Tommy Leavelle

Signature

Tommy Leavelle

Printed Name

1819 Oak Rd

Mailing Address

Luling, Tex 78048

City, State, Zip Code

Same

Residence Address

1-8-42 1-10-15

Date of Birth

Date of Signing

1019080939

Voter Registration No.

830-875-1842

Phone Number

Signature

Printed Name

Mailing Address

City, State, Zip Code

Residence Address

Date of Birth

Date of Signing

Voter Registration No.

Phone Number

Signature

Printed Name

Mailing Address

City, State, Zip Code

Residence Address

Date of Birth

Date of Signing

Voter Registration No.

Phone Number

Signature

Printed Name

Mailing Address

City, State, Zip Code

Residence Address

Date of Birth

Date of Signing

Voter Registration No.

Phone Number

Cynthia Alvarez
Signature

Cynthia Alvarez
Printed Name

3550 Idwiling RD
Mailing Address

Lockhart, TX 78644
City, State, Zip Code

3550 Idwiling RD
Residence Address

9/22/1970 1/10/15
Date of Birth Date of Signing

1003980701
Voter Registration No.

5127870247
Phone Number

Juan Alvarez
Signature

JUAN ALVAREZ JR
Printed Name

355 00 Wiling
Mailing Address

Lockhart TX 78644
City, State, Zip Code

SG MP
Residence Address

12/20/62 1/10/15
Date of Birth Date of Signing

1003962806
Voter Registration No.

512 787-7512
Phone Number

Signature

Printed Name

Mailing Address

City, State, Zip Code

Residence Address

Date of Birth Date of Signing

Voter Registration No.

Phone Number

Signature

Printed Name

Mailing Address

City, State, Zip Code

Residence Address

Date of Birth Date of Signing

Voter Registration No.

Phone Number

R. E. Schroeder
Signature

R. E. SCHROEDER
Printed Name

2742 FM 1322
Mailing Address

LOCKHART, TX. 78644
City, State, Zip Code

SAME
Residence Address

10-15-40 1-10-15
Date of Birth Date of Signing

1004021884
Voter Registration No.

Phone Number 512-398-6478

Ann Schroeder
Signature

Ann Schroeder
Printed Name

2742 FM 132'
Mailing Address

Lockhart, TX 78644
City, State, Zip Code

same
Residence Address

11-03-42 1-10-15
Date of Birth Date of Signing

1004021878
Voter Registration No.

Phone Number 512-398-6478

Signature

Printed Name

Mailing Address

City, State, Zip Code

Residence Address

Date of Birth Date of Signing

Voter Registration No.

Phone Number

Signature

Printed Name

Mailing Address

City, State, Zip Code

Residence Address

Date of Birth Date of Signing

Voter Registration No.

Phone Number

Tom Blackwell

Signature

Tom Blackwell
Printed Name

1406 S. Commerce
Mailing Address

Lockhart, TX 78644
City, State, Zip Code

5073 Fm 1322
Residence Address

10-15-47 1-12-15
Date of Birth Date of Signing

1147084749
Voter Registration No.

Phone Number 512-620-0233

Thomas Blackwell

Signature

Thomas Blackwell
Printed Name

1406 S. Commerce
Mailing Address

Lockhart TX 78644
City, State, Zip Code

6905 Fm 1322
Residence Address

05-24-83 1-12-15
Date of Birth Date of Signing

1022878516
Voter Registration No.

Phone Number 512-738-0320

Reginald W. Brown

Signature

Reginald W. Brown
Printed Name

8290 Fm 1322
Mailing Address

Lockhart, TX. 78644
City, State, Zip Code

8290 Fm 1322
Residence Address

4/3/78 1/11/15
Date of Birth Date of Signing

Voter Registration No.

512-227-1243
Phone Number

Signature

Printed Name

Mailing Address

City, State, Zip Code

Residence Address

Date of Birth Date of Signing

Voter Registration No.

Phone Number

Jo Ann Labay

Signature

Jo Ann Labay

Printed Name

1484 Old Laling Rd

Mailing Address

Lockport, IL 78644

City, State, Zip Code

Lane

Residence Address

2-2-50 10-25-14

Date of Birth

Date of Signing

1004009018

Voter Registration No.

Phone Number 512-398-7255

Phone Number

Signature

Printed Name

Mailing Address

City, State, Zip Code

Residence Address

Date of Birth

Date of Signing

Voter Registration No.

Phone Number

Signature

Printed Name

Mailing Address

City, State, Zip Code

Residence Address

Date of Birth

Date of Signing

Voter Registration No.

Phone Number

Signature

Printed Name

Mailing Address

City, State, Zip Code

Residence Address

Date of Birth

Date of Signing

Voter Registration No.

Phone Number

Arthur Evans III
Signature
ARTHUR EVANS III
Printed Name
127 ROBINSON ROAD
Mailing Address
LOCKHART TX 78644
City, State, Zip Code
127 ROBINSON RD
Residence Address
5-15-58 11-28-14
Date of Birth Date of Signing
1 004036488
Voter Registration No.
Phone Number 512-878-7538

P W Estes
Signature
JIM W. ESTES
Printed Name
7620 S. Hwy 183
Mailing Address
Lockhart, TX 78644
City, State, Zip Code
SOME
Residence Address
8 JUL 37 28 Nov 14
Date of Birth Date of Signing
-
Voter Registration No.
Phone Number 512 620 0322

Signature

Printed Name

Mailing Address

City, State, Zip Code

Residence Address

Date of Birth Date of Signing

Voter Registration No.

Phone Number

Signature

Printed Name

Mailing Address

City, State, Zip Code

Residence Address

Date of Birth Date of Signing

Voter Registration No.

Phone Number

Linda Doyle
Signature

Linda Doyle
Printed Name

832 FM 671
Mailing Address

Lockhart, Tx. 78644
City, State, Zip Code

same
Residence Address

02-23-51 09-06-14
Date of Birth Date of Signing

1006977644
Voter Registration No.

Phone Number 512-913-3066

Jerry Doyle
Signature

Jerry Doyle
Printed Name

832 FM 671
Mailing Address

Lockhart, Tx. 78644
City, State, Zip Code

SAME
Residence Address

01-27-49 09-15-14
Date of Birth Date of Signing

1006977637
Voter Registration No.

Phone Number 512-213-7267

Signature

Printed Name

Mailing Address

City, State, Zip Code

Residence Address

Date of Birth Date of Signing

Voter Registration No.

Phone Number

Signature

Printed Name

Mailing Address

City, State, Zip Code

Residence Address

Date of Birth Date of Signing

Voter Registration No.

Phone Number

ESD District 3-1080 House Value and Rent

Betty Gardner
Signature

Betty Gardner
Printed Name

1292 FM 2984
Mailing Address

Luling, Tx 78648-4494
City, State, Zip Code

1292 FM 2984
Residence Address

1/1/27 9/27/14
Date of Birth Date of Signing

1004046354
Voter Registration No.

830-875-2061
Phone Number

Shirley Ann Gardner
Signature

Shirley Ann GARDNER
Printed Name

1280 Fm 2984
Mailing Address

Luling, Texas 78648
City, State, Zip Code

1280 Fm 2984
Residence Address

5-2-47 9/27/14
Date of Birth Date of Signing

1139627779
Voter Registration No.

830-875-5622
Phone Number

Kathryn L. Goerdel
Signature

Kathryn L. Goerdel
Printed Name

1328 Fm 2984
Mailing Address

Luling, Tx 78648
City, State, Zip Code

1328 Fm 2984
Residence Address

12-3-1950 9/27/14
Date of Birth Date of Signing

1004025620
Voter Registration No.

830-875-2905
Phone Number

Kent D. Goerdel
Signature

Kent D. Goerdel
Printed Name

1328 Fm 2984
Mailing Address

Luling, Tx 78648
City, State, Zip Code

1328 Fm 2984
Residence Address

1-16-1950 9-27-14
Date of Birth Date of Signing

1004306119
Voter Registration No.

830-875-2905
Phone Number

Nancy Fogle
Signature

Nancy Fogle
Printed Name

5231 State Park Rd.
Mailing Address

Lockhart, TX 78644
City, State, Zip Code

5231 State Park Rd.
Residence Address

12-15-1956 11-28-14
Date of Birth Date of Signing

1004036966
Voter Registration No.

(512) 376-3378
Phone Number

Billy D Fogle
Signature

BILLY D FOGLE
Printed Name

5231 STATE PARK RD
Mailing Address

LOCKHART, TX 78644
City, State, Zip Code

5231 STATE PARK RD
Residence Address

9/30/1955 11/28/2014
Date of Birth Date of Signing

1006978329
Voter Registration No.

(512) 376-3378
Phone Number

Ann Rucker
Signature

ANNIE RUCKER
Printed Name

P.O. Box 1237
Mailing Address

LOCKHART, TX 78644
City, State, Zip Code

3422 Westwood Rd
Residence Address

10-12-42 11-28-14
Date of Birth Date of Signing

1006242938
Voter Registration No.

512 557-2384
Phone Number

Patty Rucker
Signature

PATTY RUCKER
Printed Name

P.O. Box 1237
Mailing Address

lockhart, TX 78644
City, State, Zip Code

3422 Westwood Rd.
Residence Address

9-29-43 11-28-14
Date of Birth Date of Signing

1003952855
Voter Registration No.

512 557-2384
Phone Number

Melba D Reed

Signature

Melba D Reed

Printed Name

426 Old Luling Rd

Mailing Address

Lockhart Texas 78644

City, State, Zip Code

Same

Residence Address

5-5-1934 10-25-2014

Date of Birth

Date of Signing

1004010886

Voter Registration No.

512 376 5355

Phone Number

Veda L. Harrison

Signature

VEDA L. HARRISON

Printed Name

426 Old Luling Rd.

Mailing Address

LOCKHART TEXAS

City, State, Zip Code

SAME

Residence Address

5-11-33 10-25-14

Date of Birth

Date of Signing

1003999141

Voter Registration No.

512-378-6645

Phone Number

Leonard M. Harrison

Signature

Leonard M. Harrison

Printed Name

423 Old Luling Rd.

Mailing Address

Lockhart, Tx. 78644-3921

City, State, Zip Code

SAME

Residence Address

11-30-29 10-25-14

Date of Birth

Date of Signing

1004008794

Voter Registration No.

512-378-6645

Phone Number

Signature

Printed Name

Mailing Address

City, State, Zip Code

Residence Address

Date of Birth Date of Signing

Voter Registration No.

Phone Number

Donald Cochran
Signature

Donald Cochran
Printed Name

Box 151
Mailing Address

LOCKHART, Tex 78644
City, State, Zip Code

Residence Address

8/26/53 12/1/84
Date of Birth Date of Signing

1004036643
Voter Registration No.

398-5034
Phone Number

Signature

Printed Name

Mailing Address

City, State, Zip Code

Residence Address

Date of Birth Date of Signing

Voter Registration No.

Phone Number

Signature

Printed Name

Mailing Address

City, State, Zip Code

Residence Address

Date of Birth Date of Signing

Voter Registration No.

Phone Number

Signature

Printed Name

Mailing Address

City, State, Zip Code

Residence Address

Date of Birth Date of Signing

Voter Registration No.

Phone Number

Signature Charles A. Johnson
Signature CHARLES A. JOHNSON
Printed Name
Printed Name
Mailing Address 9075 S. 183 LOCKHART
Mailing Address
City, State, Zip Code LOCKHART ST. 78644
City, State, Zip Code
Residence Address SAME
Residence Address
Date of Birth 6-25-1943 Date of Signing 9-27-2014
Date of Birth Date of Signing
Voter Registration No. 1003998433
Voter Registration No.
Phone Number 512-376 6584 Phone Number

Signature	Signature
Printed Name	Printed Name
Mailing Address	Mailing Address
City, State, Zip Code	City, State, Zip Code
Residence Address	Residence Address
Date of Birth	Date of Birth
Date of Signing	Date of Signing
Voter Registration No.	Voter Registration No.
Phone Number	Phone Number

Katherine King
Signature

KATHERINE KING
Printed Name

344 FM 2984
Mailing Address

Loving, TX 78648
City, State, Zip Code

SAME
Residence Address

8-24-35 9-20-14
Date of Birth Date of Signing

1004040225
Voter Registration No.

830-875-3980
Phone Number

Signature

Printed Name

Mailing Address

City, State, Zip Code

Residence Address

Date of Birth Date of Signing

Voter Registration No.

Phone Number

Signature

Printed Name

Mailing Address

City, State, Zip Code

Residence Address

Date of Birth Date of Signing

Voter Registration No.

Phone Number

Signature

Printed Name

Mailing Address

City, State, Zip Code

Residence Address

Date of Birth Date of Signing

Voter Registration No.

Phone Number

Daniel Graham
Signature

Daniel Graham
Printed Name

1205 Graham Rd.
Mailing Address

Lockhart, TX. 78644
City, State, Zip Code

Same
Residence Address

07-17-1972 11-30-2014
Date of Birth Date of Signing

1015378185
Voter Registration No.

Phone Number 512-284-0678

Marie Graham
Signature

Marie Graham
Printed Name

1205 Graham Rd.
Mailing Address

Lockhart, Tx. 78644
City, State, Zip Code

Same
Residence Address

10-23-1978 11-30-2014
Date of Birth Date of Signing

1158384710
Voter Registration No.

Phone Number 512-284-0677

Signature

Printed Name

Mailing Address

City, State, Zip Code

Residence Address

Date of Birth Date of Signing

Voter Registration No.

Phone Number

Signature

Printed Name

Mailing Address

City, State, Zip Code

Residence Address

Date of Birth Date of Signing

Voter Registration No.

Phone Number

Andrew Houser
Signature

Andrew Houser
Printed Name

229 Hidden Hollow
Mailing Address

Lockhart, TX 78644
City, State, Zip Code

Residence Address

4-4-85 11-30-14
Date of Birth Date of Signing

1089314648
Voter Registration No.

512-227-4559
Phone Number

Randelyn Houser
Signature

Randelyn Houser
Printed Name

229 Hidden Hollow
Mailing Address

Lockhart, TX 78644
City, State, Zip Code

Residence Address

12-1-86 11-30-14
Date of Birth Date of Signing

1132146397
Voter Registration No.

61
Phone Number

Signature

Printed Name

Mailing Address

City, State, Zip Code

Residence Address

Date of Birth Date of Signing

Voter Registration No.

Phone Number

Signature

Printed Name

Mailing Address

City, State, Zip Code

Residence Address

Date of Birth Date of Signing

Voter Registration No.

Phone Number

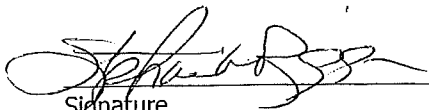
Signature
Stephanie Riggan
Printed Name
1165 FM-671
Mailing Address
Lockhart, TX 78644
City, State, Zip Code
1165 FM 671
Residence Address
06/03/85 12-1-14
Date of Birth Date of Signing
1003989955
Voter Registration No.
Phone Number 512/376-8565

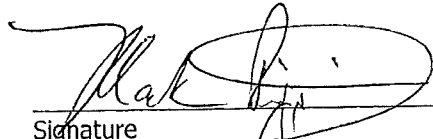
Signature
Mark Riggan
Printed Name
1165 FM-671
Mailing Address
Lockhart, TX 78644
City, State, Zip Code
1165 FM-671
Residence Address
03-09-58 12-1-14
Date of Birth Date of Signing
1003989964
Voter Registration No.
Phone Number 512/376-8564

Signature

Printed Name

Mailing Address

City, State, Zip Code

Residence Address

Date of Birth Date of Signing

Voter Registration No.

Phone Number

Signature

Printed Name

Mailing Address

City, State, Zip Code

Residence Address

Date of Birth Date of Signing

Voter Registration No.

Phone Number

Kenneth Henderson
Signature
Kenneth Henderson
Printed Name
P.O. Box 1413
Mailing Address
Lockhart Tx. 78644
City, State, Zip Code
227 Henderson Ln.
Residence Address
11/18/1967 10/18/2014
Date of Birth Date of Signing
1003990663
Voter Registration No.
512 738-1382
Phone Number

Yvonne Cano-Henderson
Signature
YVONNE CANO-HENDERSON
Printed Name
P.O. Box 1413
Mailing Address
Lockhart, TX 78644
City, State, Zip Code
227 Henderson Ln
Residence Address
12/12/68 10/18/14
Date of Birth Date of Signing
1003962501
Voter Registration No.
512 227-6419
Phone Number

Signature

Printed Name

Mailing Address

City, State, Zip Code

Residence Address

Date of Birth Date of Signing

Voter Registration No.

Phone Number

Signature

Printed Name

Mailing Address

City, State, Zip Code

Residence Address

Date of Birth Date of Signing

Voter Registration No.

Phone Number

Shirley Sanders
Signature

SHIRLEY SANDERS
Printed Name

2368 Fm 2984
Mailing Address

LULING TX 78648
City, State, Zip Code

SAME
Residence Address

6-19-57 10-18-14
Date of Birth Date of Signing

1004016074
~~1004016074~~
Voter Registration No.

512-665-6542
Phone Number

Faith Sanders
Signature

Faith Sanders
Printed Name

2416 Fm 2984
Mailing Address

Luling Tx 78648
City, State, Zip Code

Same
Residence Address

7-20-74 10-19-14
Date of Birth Date of Signing

1018081097
Voter Registration No.

512 227-1886
Phone Number

Mark Sanders
Signature

MARK SANDERS
Printed Name

2416 FM 2984
Mailing Address

LULING, TX. 78648
City, State, Zip Code

SAME
Residence Address

8-7-70 10-18-14
Date of Birth Date of Signing

1023030903
Voter Registration No.

(512) 801-1271
Phone Number

Mary C Sanders
Signature

MARY C. SANDERS
Printed Name

2532 FM 2984
Mailing Address

Luling, TX 78648
City, State, Zip Code

SAME
Residence Address

6/5/38 10/19/14
Date of Birth Date of Signing

1004046417
Voter Registration No.

830 875-9143
Phone Number

[Signature]
Signature

Silvestre Serna
Printed Name

559 Old Luling Rd
Mailing Address

Lockhart TX
City, State, Zip Code

Same
Residence Address

01-21-63 10-25-14
Date of Birth Date of Signing

1004025497
Voter Registration No.

Phone Number 512 376-2777

[Signature]
Signature

Brenda Ann Serna
Printed Name

559 Old Luling Rd
Mailing Address

Lockhart TX 78644
City, State, Zip Code

Same
Residence Address

09-11-67 10-25-14
Date of Birth Date of Signing

1145631138
Voter Registration No.

Phone Number 512 376-2777

[Signature]
Signature

Ronald Taylor
Printed Name

1350 Old Luling
Mailing Address

LH TX
City, State, Zip Code

Same
Residence Address

9-21-53 10-25-14
Date of Birth Date of Signing

Voter Registration No.

Phone Number 512 410 6682

Signature

Printed Name

Mailing Address

City, State, Zip Code

Residence Address

Date of Birth Date of Signing

Voter Registration No.

Phone Number

David J Kinsfather
Signature

DAVID J KINSFATHER
Printed Name

271 KINSEY TRAIL
Mailing Address

Luling, Tx 78648
City, State, Zip Code

271 KINSEY TRAIL
Residence Address

01-18-1949 11-30-14
Date of Birth Date of Signing

1004046775
Voter Registration No.

512-964-3060
Phone Number

Signature

Printed Name

Mailing Address

City, State, Zip Code

Residence Address

Date of Birth Date of Signing

Voter Registration No.

Phone Number

Bobby Robertson
Signature

Bobby Robertson
Printed Name

3107 FM 671
Mailing Address

Luling, Tx. 78648
City, State, Zip Code

3107 FM 671, Luling, Tx.
Residence Address

1-11-39 _____
Date of Birth Date of Signing

1013884829
Voter Registration No.

512-620-1426
Phone Number

Jimaree Robertson
Signature

JIMAREE ROBERTSON
Printed Name

3107 FM 671
Mailing Address

Luling, Tx. 78648
City, State, Zip Code

3107 FM 671, Luling, Tx.
Residence Address

5-24-44 _____
Date of Birth Date of Signing

1013885264
Voter Registration No.

281-236-7023
Phone Number

Gloria Coit
Signature

Gloria Coit
Printed Name

133 CLEARFORK RD
Mailing Address

LOCKHART, TX 78644
City, State, Zip Code

SAME
Residence Address

8-21-35 11-30-14
Date of Birth Date of Signing

1004011420
Voter Registration No.

512-376-9057
Phone Number

RE Brown III
Signature

Robert E Brown III
Printed Name

8560 FM 1322
Mailing Address

Lockhart Tx 78644
City, State, Zip Code

Same
Residence Address

7/31/48 11/30/14
Date of Birth Date of Signing

1004021845
Voter Registration No.

512-995-0653
Phone Number

C. Mitchell
Signature

Cindy Mitchell
Printed Name

7627 FM 1322
Mailing Address

LOCKHART TX 78644
City, State, Zip Code

7669 FM 1322
Residence Address

2-17-56 11-30-14
Date of Birth Date of Signing

1003974518
Voter Registration No.

512-376-1964
Phone Number

Signature

Printed Name

Mailing Address

City, State, Zip Code

Residence Address

Date of Birth Date of Signing

Voter Registration No.

Phone Number

Call #

Karla Field
Signature

Karla Field
Printed Name

P.O. Box 567
Mailing Address

Lockhart, Tx 78644
City, State, Zip Code

901 Robin Ranch Rd
Residence Address Lockhart, Tx

7-12-59 10-28-14
Date of Birth Date of Signing

1003970718
Voter Registration No.

Phone Number 512-398-7884

[Signature]
Signature

Douglas Field
Printed Name

P.O. Box 567
Mailing Address

Lockhart, Tx 78644
City, State, Zip Code

901 Robin Ranch Rd,
Residence Address

1-20-59 10-28-14
Date of Birth Date of Signing

1003970702
Voter Registration No.

Phone Number 512-398-7884

Signature

Printed Name

Mailing Address

City, State, Zip Code

Residence Address

Date of Birth Date of Signing

Voter Registration No.

Phone Number

Signature

Printed Name

Mailing Address

City, State, Zip Code

Residence Address

Date of Birth Date of Signing

Voter Registration No.

Phone Number

Arcey J Mendez
Signature

Nickey F. Mendez
Printed Name

1302 FM 671
Mailing Address

Rockport Tx 78644
City, State, Zip Code

1302 FM 671
Residence Address

10-15-69 10-20-15
Date of Birth Date of Signing

1006277545
Voter Registration No.

512-557-9325
Phone Number

Raymond A Mendez
Signature

Raymond A Mendez
Printed Name

1302 FM 671
Mailing Address

Rockport Tx 78644
City, State, Zip Code

1302 FM 671
Residence Address

9-1-62 10-20-15
Date of Birth Date of Signing

1009073642
Voter Registration No.

512-749-2405
Phone Number

Signature

Printed Name

Mailing Address

City, State, Zip Code

Residence Address

Date of Birth Date of Signing

Voter Registration No.

Phone Number

Signature

Printed Name

Mailing Address

City, State, Zip Code

Residence Address

Date of Birth Date of Signing

Voter Registration No.

Phone Number

Tommy Wingard
Signature
Tommy Wingard
Printed Name
955 Old Luling Rd
Mailing Address
Lockhart, Tx 78644
City, State, Zip Code
Same
Residence Address
9-19-14
Date of Birth Date of Signing
1013882236
Voter Registration No.
612-497-5344
Phone Number

Christian Martinez
Signature
Christian Martinez
Printed Name
6860 Sea Willow RD
Mailing Address
Lockhart TX 78644
City, State, Zip Code
Same
Residence Address
2-14-90 11-30-14
Date of Birth Date of Signing
Voter Registration No.
512-216-8107
Phone Number

Lisa Martinez
Signature
Lisa Martinez
Printed Name
6860 Sea Willow
Mailing Address
Lockhart TX 78644
City, State, Zip Code
Same
Residence Address
7-28-87 11-30-14
Date of Birth Date of Signing
Voter Registration No.
970-980-9591
Phone Number

Signature

Printed Name

Mailing Address

City, State, Zip Code

Residence Address

Date of Birth Date of Signing

Voter Registration No.

Phone Number

Jane D. Gonzalez
Signature

Jane D. Gonzalez
Printed Name

935 Union Hill Rd.
Mailing Address

Luling, TX 78648
City, State, Zip Code

Same ↑
Residence Address

May 29, 1986 Nov. 30, 2014
Date of Birth Date of Signing

1188293217
Voter Registration No.

512-629-8048
Phone Number

Jane D. Gonzalez
Signature

Jane D. Gonzalez
Printed Name

935 Union Hill Rd.
Mailing Address

Luling, TX 78648
City, State, Zip Code

↑ same
Residence Address

01-31-86 11-30-14
Date of Birth Date of Signing

Voter Registration No.

512-629-8048
Phone Number

Mia Bunker
Signature

Mia Bunker
Printed Name

240 Sunset Trail
Mailing Address

Luling, TX 78648
City, State, Zip Code

Same
Residence Address

10/29/81 11/30/14
Date of Birth Date of Signing

Voter Registration No.

512 558 1993
Phone Number

Signature

Printed Name

Mailing Address

City, State, Zip Code

Residence Address

Date of Birth Date of Signing

Voter Registration No.

Phone Number

Stanley Haddock
Signature

Stanley Haddock
Printed Name

725 Pin Oak
Mailing Address

Lockhart TX 78644
City, State, Zip Code

Same
Residence Address

7-9-40 11-8-14
Date of Birth Date of Signing

1003978377
Voter Registration No.

Phone Number 512-497-9332

Sally Haddock
Signature

Sally Haddock
Printed Name

725 Pin Oak Rd.
Mailing Address

Lockhart TX 78644
City, State, Zip Code

Same
Residence Address

9-9-40 11-8-14
Date of Birth Date of Signing

1003978527
Voter Registration No.

Phone Number ~~512-9374~~ 512 497-9332

Signature

Printed Name

Mailing Address

City, State, Zip Code

Residence Address

Date of Birth Date of Signing

Voter Registration No.

Phone Number

Signature

Printed Name

Mailing Address

City, State, Zip Code

Residence Address

Date of Birth Date of Signing

Voter Registration No.

Phone Number

Blake Stone
Signature
Blake Stone
Printed Name
51 Mineral Springs
Mailing Address
Lockhart TX 78644
City, State, Zip Code
Same
Residence Address
3/10/14 11/30/14
Date of Birth Date of Signing

Voter Registration No.
Phone Number 520-233-4611

Brian Holly
Signature
Brian L Holly
Printed Name
1225 Washburn Rd
Mailing Address
Luling TX 78648
City, State, Zip Code
Same
Residence Address
5-8-70 11/30/14
Date of Birth Date of Signing
1023887015
Voter Registration No.
Phone Number 830 875 5492

Julie L Holly
Signature
Julie L Holly
Printed Name
1225 Washburn Rd
Mailing Address
Luling TX 78648
City, State, Zip Code
Same
Residence Address
7-4-62 11/30/14
Date of Birth Date of Signing
1023887027
Voter Registration No.
830 875 5492
Phone Number

Signature

Printed Name

Mailing Address

City, State, Zip Code

Residence Address

Date of Birth Date of Signing

Voter Registration No.

Phone Number

Donald J. Maher
Signature

DONALD J MAHER
Printed Name

1350 YOUNG LANE
Mailing Address

LOCKHART TX
City, State, Zip Code

78644
Residence Address

6-7-31 10-19-14
Date of Birth Date of Signing

Voter Registration No.

Alma N. Perez
Signature

1432 YOUNG LN
Printed Name

LOCKHART, TX 78644
Mailing Address

City, State, Zip Code

Residence Address

7-30-34 10-19-14
Date of Birth Date of Signing

Voter Registration No.

Edward P. Perez
Signature

EDWARD P. PEREZ
Printed Name

1432 YOUNG LANE
Mailing Address

LOCKHART TEX 78644
City, State, Zip Code

Residence Address

7-9-34 10-19-2014
Date of Birth Date of Signing

1004001674
Voter Registration No.

Angel L. Gomez
Signature

Angel L. Gomez
Printed Name

Mailing Address

1450 YOUNG LN
City, State, Zip Code

LOCKHART, TX 78644
Residence Address

Date of Birth Date of Signing

1004012626
Voter Registration No.

Chris Norman
Signature

Chris Norman
Printed Name

8069 State Park Rd
Mailing Address

Lockhart, TX 78644
City, State, Zip Code

same
Residence Address

5/2/76 11-08-14
Date of Birth Date of Signing

1010876302
Voter Registration No.

Phone Number

[Signature]
Signature

Leigh C Trent
Printed Name

8069 State Park Rd
Mailing Address

Lockhart, TX 78644
City, State, Zip Code

Same
Residence Address

11/3/53 11/8/14
Date of Birth Date of Signing

1212337613
Voter Registration No.

Phone Number

Signature

Printed Name

Mailing Address

City, State, Zip Code

Residence Address

Date of Birth Date of Signing

Voter Registration No.

Phone Number

Signature

Printed Name

Mailing Address

City, State, Zip Code

Residence Address

Date of Birth Date of Signing

Voter Registration No.

Phone Number

[Signature]
Signature

TERRY RHEINLANDER
Printed Name

84 OMA'S LN
Mailing Address

LOCKHART TX 78644
City, State, Zip Code

SAME
Residence Address

10-18-57 11-8-14
Date of Birth Date of Signing

1004017448
Voter Registration No.

Phone Number 512-376-5334

[Signature]
Signature

LINDA RHEINLANDER
Printed Name

84 OMA'S LN
Mailing Address

LOCKHART TX 78644
City, State, Zip Code

SAME
Residence Address

3-28-57 11-8-14
Date of Birth Date of Signing

1161959016
Voter Registration No.

Phone Number 512-376-5332

[Signature]
Signature

PAUL RHEINLANDER
Printed Name

100 OMA'S LAURE
Mailing Address

Lockhart Tx 78644
City, State, Zip Code

Same
Residence Address

4/16/59 11/8/14
Date of Birth Date of Signing

Voter Registration No.

Phone Number 512 217-5095

[Signature]
Signature

Michael Rheinlander
Printed Name

168 OMA'S LN
Mailing Address

Lockhart Tx 78644
City, State, Zip Code

Same
Residence Address

02/13/1974 11/18/14
Date of Birth Date of Signing

Voter Registration No.

Phone Number 512-517-3702



Signature

Mark West
Printed Name

10606 S Hwy 183
Mailing Address

Wadsworth, TX 78644
City, State, Zip Code

Same
Residence Address

06/21/66 10/22/14
Date of Birth Date of Signing

1006200595
Voter Registration No.

830-875-2110
Phone Number

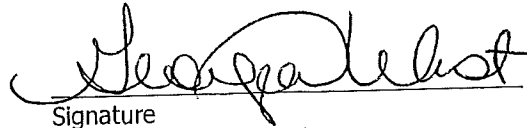

Signature

Georgia West
Printed Name

10606 S Hwy 183
Mailing Address

Wadsworth, TX 78644
City, State, Zip Code

Same
Residence Address

9/12/64 10/22/14
Date of Birth Date of Signing

1004022469
Voter Registration No.

830-875-2110
Phone Number

Signature

Printed Name

Mailing Address

City, State, Zip Code

Residence Address

Date of Birth Date of Signing

Voter Registration No.

Phone Number

Signature

Printed Name

Mailing Address

City, State, Zip Code

Residence Address

Date of Birth Date of Signing

Voter Registration No.

Phone Number

John H. Gruczwa
Signature

John H. Gruczwa
Printed Name

PO Box 394
Mailing Address

Lockhart TX 78644
City, State, Zip Code

5541 STATE PARK RD
Residence Address

11/26/1950 11/29/2014
Date of Birth Date of Signing

1014976869
Voter Registration No.

512-398-3568
Phone Number

Robert L. Pickens
Signature

Robert L. Pickens
Printed Name

8333 State Park Rd.
Mailing Address

Lockhart, TX 78644
City, State, Zip Code

SAME
Residence Address

7-23-74 11-29-14
Date of Birth Date of Signing

1176712403
Voter Registration No.

512-940-2882
Phone Number

Christopher A Post
Signature

Christopher A Post
Printed Name

5447 State Park Rd
Mailing Address

Lockhart, TX 78644
City, State, Zip Code

SAME
Residence Address

7/20/1959 11/29/14
Date of Birth Date of Signing

1136954639
Voter Registration No.

512-376-2363
Phone Number

Curtis Gibson
Signature

Curtis Gibson
Printed Name

2085 OAK GROVE
Mailing Address

Luling
City, State, Zip Code

78648
Residence Address

7-23-61
Date of Birth Date of Signing

1006200818
Voter Registration No.

875-5900
Phone Number

Gloria Eddleton
Signature
Gloria Eddleton
Printed Name
514 Lay Road
Mailing Address
Lockhart TX 78644
City, State, Zip Code

Residence Address
9-28-14
Date of Birth Date of Signing
1004009060
Voter Registration No.

Amy Seitz
Signature
Amy Seitz
Printed Name
420 Lay Rd.
Mailing Address
Lockhart, TX 78644
City, State, Zip Code

Residence Address
4-20-75 9-28-14
Date of Birth Date of Signing
1004017051
Voter Registration No.

Patricia Leonard
Signature
616 Lay Road
Printed Name
Patricia Leonard
Mailing Address
Lockhart, Tx 78644
City, State, Zip Code

Residence Address
9-28-14
Date of Birth Date of Signing
1003998873
Voter Registration No.

Patricia Leonard
Signature

Printed Name

Mailing Address

City, State, Zip Code

Residence Address

Date of Birth Date of Signing

Voter Registration No.

Nati Castanon

Signature

Nati Castanon

Printed Name

6071 S. Hwy 183

Mailing Address

Lockhart, Tx 78644

City, State, Zip Code

6071 S. Hwy 183

Residence Address

12-24-55 10-22-14

Date of Birth

Date of Signing

1004025198

Voter Registration No.

Phone Number 512-376-5541

Phone Number

Doris Davila

Signature

Doris Davila

Printed Name

475 Catfish lane

Mailing Address

Lockhart TX 78644

City, State, Zip Code

same

Residence Address

4/13/59 10/22/19

Date of Birth

Date of Signing

1042618144

Voter Registration No.

Phone Number 512 748 3338

Phone Number

Royen Smith

Signature

Royen Smith

Printed Name

475 CATFISH LANE

Mailing Address

LOCKHART TX 78644

City, State, Zip Code

SAME

Residence Address

03/27/1960 10/22/19

Date of Birth

Date of Signing

104 1014513887

Voter Registration No.

Phone Number (512) 422-8931

Phone Number

Signature

Printed Name

Mailing Address

City, State, Zip Code

Residence Address

Date of Birth Date of Signing

Voter Registration No.

Phone Number

Gretchen Moore
Signature

Gretchen Moore
Printed Name

7839 FM 1322
Mailing Address

Lockhart TX 78644
City, State, Zip Code

Same
Residence Address

05-28-74 9-7-2014
Date of Birth Date of Signing

1003998498
Voter Registration No.

Phone Number

Russell Tiner
Signature

RUSSELL TINER
Printed Name

510 BROWNSBORO LN
Mailing Address

Lockhart TX 78644
City, State, Zip Code

510 Brownsboro Ln
Residence Address

1-31-67 9-8-14
Date of Birth Date of Signing

1003990659
Voter Registration No.

512 / 227 / 2272
Phone Number

Charlene Tiner
Signature

Charlene Tiner
Printed Name

510 Brownsboro Lane
Mailing Address

Lockhart, Tx 78644
City, State, Zip Code

Same
Residence Address

10-6-1970 9-7-2014
Date of Birth Date of Signing

1003954524
Voter Registration No.

Phone Number

Tommy L Blackshear
Signature

Tommy L Blackshear
Printed Name

3012 FM 621
Mailing Address

Lockhart TX, 78648
City, State, Zip Code

Residence Address

10/19/35 Sept. 20, 2014
Date of Birth Date of Signing

1003983580
Voter Registration No.

Phone Number

Charles H. Tolley
Signature

Charles H. Tolley
Printed Name

1804 Seawillow Rd.
Mailing Address

Lockhart, Tx. 78644
City, State, Zip Code

Residence Address

28 Sept 2014
Date of Birth Date of Signing

1019923900
Voter Registration No.

Debbie Haun
Signature

Debbie Haun
Printed Name

PO Box 1048
Mailing Address

Lockhart TX 78644
City, State, Zip Code

1381 Seawillow Rd
Residence Address

9-28-14
Date of Birth Date of Signing

1205689632
Voter Registration No.

James A. Haun
Signature

JAMES A. HAUN
Printed Name

P.O. Box 1048
Mailing Address

LOCKHART, TX - 78644
City, State, Zip Code

1381 SEAWILLOW RD.
Residence Address

8-24-47 9-29-14
Date of Birth Date of Signing

1003990600
Voter Registration No.

J. T. Statton
Signature

J. T. STATTON
Printed Name

2000 SEAWILLOW
Mailing Address

LOCKHART TX 78644
City, State, Zip Code

2000 Seawillow Rd,
Residence Address

11-2-46 9/28/2014
Date of Birth Date of Signing

1101413779
Voter Registration No.

Antonio C Merka

Signature

Antonio C MERKA

Printed Name

407 Sierra Dr

Mailing Address

Cockhart TX 78644

City, State, Zip Code

Signature

Printed Name

Mailing Address

City, State, Zip Code

Residence Address

11/23/40 *11/5/14*

Date of Birth

Date of Signing

1166421600

Voter Registration No.

5128092888

Phone Number

Residence Address

Date of Birth

Date of Signing

Voter Registration No.

Phone Number

Signature

Printed Name

Mailing Address

City, State, Zip Code

Residence Address

Date of Birth

Date of Signing

Voter Registration No.

Phone Number

Signature

Printed Name

Mailing Address

City, State, Zip Code

Residence Address

Date of Birth

Date of Signing

Voter Registration No.

Phone Number

Kath Moore

Signature

Katherine Moore

Printed Name

10508 S. US Hwy 183

Mailing Address

Lockhart TX 78644

City, State, Zip Code

10508 S US Hwy 183

Residence Address

10/16/1974 10/25/14

Date of Birth

Date of Signing

1026455591

Voter Registration No.

912-450-2014

Phone Number

Signature

Printed Name

Mailing Address

City, State, Zip Code

Residence Address

Date of Birth

Date of Signing

Voter Registration No.

Phone Number

Robert J. DeFurion

Signature

ROBERT J DEFURION

Printed Name

P.O Box 473

Mailing Address

LOCKHART, TX 78644

City, State, Zip Code

28 South Lane

Residence Address

29 Jan. 1936 25 Oct 2014

Date of Birth

Date of Signing

Voter Registration No.

398 2067

Phone Number

Signature

Printed Name

Mailing Address

City, State, Zip Code

Residence Address

Date of Birth

Date of Signing

Voter Registration No.

Phone Number

Frank Robinson
Signature

Signature

Frank Robinson
Printed Name

Printed Name

310 Paintbrush Trail
Mailing Address

Mailing Address

Lockhart, Tx 78644
City, State, Zip Code

City, State, Zip Code

310 Paintbrush Trail
Residence Address

Residence Address

9-21-47 11-8-14
Date of Birth Date of Signing

Date of Birth Date of Signing

1004038366
Voter Registration No.

Voter Registration No.

Phone Number 512-558-1026

Phone Number

Signature

Signature

Printed Name

Printed Name

Mailing Address

Mailing Address

City, State, Zip Code

City, State, Zip Code

Residence Address

Residence Address

Date of Birth Date of Signing

Date of Birth Date of Signing

Voter Registration No.

Voter Registration No.

Phone Number

Phone Number

Nelda F. Seitz
Signature
NELDA F. SEITZ
Printed Name
1182 Seawillow Rd.
Mailing Address
Lockhart, Tx 78644
City, State, Zip Code

Alfred F. Seitz
Signature
ALFRED-F-SEITZ
Printed Name
1182 Seawillow Rd
Mailing Address
Lockhart Tex. 78644
City, State, Zip Code

Residence Address

Residence Address

Date of Birth Date of Signing

11-6-37 10-20-2014
Date of Birth Date of Signing

7/11/1942 Oct 19, 2014
Voter Registration No. 1003983800

1006235033
Voter Registration No.

[Signature]
Signature

Kimberely L Cain
Signature

Shaun Cain
Printed Name

Kimberely Cain
Printed Name

P.O. Box 356
Mailing Address

P.O. Box 356
Mailing Address

Prairie Lea, Tx 78661
City, State, Zip Code

Prairie Lea TX. 78661
City, State, Zip Code

1255 Plant Rd. Luling, TX
Residence Address 78648

1255 Plant Rd Luling TX. 78648
Residence Address

3/25/80 10-19-14
Date of Birth Date of Signing

8-9-81 10-19-14
Date of Birth Date of Signing

Voter Registration No.

Voter Registration No.

Clint Mohle
Signature
CLINT MOHLE
Printed Name
3192 SEAWILLOW RD.
Mailing Address
LOCKHART, TX 78644
City, State, Zip Code
SAME
Residence Address
8-16-60 10-19-14
Date of Birth Date of Signing
1004010791
Voter Registration No.

Julie A Mohle
Signature
Julie A Mohle
Printed Name
3192 Seawillow Rd
Mailing Address
Lockhart, TX 78644
City, State, Zip Code
SAME
Residence Address
10-31-62 10-19-14
Date of Birth Date of Signing
1004010801
Voter Registration No.

Kathy Mondin
Signature
Kathryn Ann Mondin
Printed Name
3430 Seawillow Rd
Mailing Address
Lockhart, TX 78644
City, State, Zip Code
3430 Seawillow
Residence Address
6-28-68 10-19-14
Date of Birth Date of Signing
1006235014
Voter Registration No.

Shane Mondin
Signature
SHANE Mondin
Printed Name
3430 Seawillow Rd
Mailing Address
Lockhart, TX 78644
City, State, Zip Code
3430 Seawillow Rd
Residence Address
8-11-67 10-19-14
Date of Birth Date of Signing
1003954548
Voter Registration No.

Carmen Gomez
Signature

CARMEN Gomez
Printed Name

1450 Young Ln
Mailing Address

Lockhart, Tx 78644
City, State, Zip Code

3 Dame
Residence Address

2-11-4 10-19-14
Date of Birth Date of Signing

1004031014
Voter Registration No.

Hipolito R Lara
Signature

HIPOLITO LARA
Printed Name

1661 Young Ln
Mailing Address

LOCKHART, TX 78644
City, State, Zip Code

8-13-1958
Residence Address

Date of Birth 10-19-2014
Date of Signing

Voter Registration No.

Tomas
Signature

Tomas Lara
Printed Name

1659 Young Ln
Mailing Address

Lockhart Tx 78644
City, State, Zip Code

Residence Address

2-15-1967 10-19-14
Date of Birth Date of Signing

1175384673
Voter Registration No.

Ella Lourea
Signature

Printed Name

Mailing Address

Lockhart, Tx 78644
City, State, Zip Code

Residence Address

Date of Birth 10-19-14
Date of Signing

Voter Registration No.

Jerry Kelley
Signature
JERRY KELLEY
Printed Name
965 Young Lane
Mailing Address
Lockhart, TX 78644
City, State, Zip Code
SAME
Residence Address
9-26-53 10-19-14
Date of Birth Date of Signing
1004019613
Voter Registration No.

Debra Estrada
Signature
Debra Estrada
Printed Name
1047 Young Ln
Mailing Address
Lockhart, TX 78644
City, State, Zip Code
SAME
Residence Address
4-8-62 10-19-14
Date of Birth Date of Signing
1004031815
Voter Registration No.

Thomas Britt Boyd
Signature
THOMAS BRITT BOYD
Printed Name
418 FM 2984
Mailing Address
Huling TX 78648
City, State, Zip Code
SAME
Residence Address
05-06-74 10-19-14
Date of Birth Date of Signing
1004019613
Voter Registration No.

Darla Kay Williams
Signature
DARLA KAY WILLIAMS
Printed Name
1091 Young Lane
Mailing Address
Lockhart Texas 78644
City, State, Zip Code
SAME
Residence Address
12-02-1939 10-17-14
Date of Birth Date of Signing
1006234971
Voter Registration No.

Donald Parkmeier
Signature

Donald Parkmeier
Printed Name

61 Acres Rd
Mailing Address

Lockhart TX 78644
City, State, Zip Code

Residence Address

10-13-54 10-8-14
Date of Birth Date of Signing

1004041970
Voter Registration No.

Phone Number 517-677-2695

Signature

Printed Name

Mailing Address

City, State, Zip Code

Residence Address

Date of Birth Date of Signing

Voter Registration No.

Phone Number

Signature

Printed Name

Mailing Address

City, State, Zip Code

Residence Address

Date of Birth Date of Signing

Voter Registration No.

Phone Number

Signature

Printed Name

Mailing Address

City, State, Zip Code

Residence Address

Date of Birth Date of Signing

Voter Registration No.

Phone Number

Kevin Cordier
Signature

Kevin Cordier
Printed Name

9765 State Park Rd
Mailing Address

Lockhart TX, 78644
City, State, Zip Code

Same
Residence Address

3-17-64 11-8-14
Date of Birth Date of Signing

1029670704
Voter Registration No.

Phone Number 512-213-7018

Signature

Printed Name

Mailing Address

City, State, Zip Code

Residence Address

Date of Birth Date of Signing

Voter Registration No.

Phone Number

Signature

Printed Name

Mailing Address

City, State, Zip Code

Residence Address

Date of Birth Date of Signing

Voter Registration No.

Phone Number

Signature

Printed Name

Mailing Address

City, State, Zip Code

Residence Address

Date of Birth Date of Signing

Voter Registration No.

Phone Number

2015.01.20.18 Adjournment.